

**nicoline**

**TIMELESS**

Sofas





*Chapter 01 \_ Sofas / Divani*

*Chapter 02 \_ Photo description / Descrizione foto*



*Chapter 03 \_ Technical Sheets / Disegni tecnici*



Airon, Antares Leg,  
Antares Living, Bolton,  
Bresso, Canaletto, Cavour,  
Claire, Ghisolfa, Manzoni Big,  
Monforte, Papillon,  
Pisa, Shelley, Sirio, Tiziano,  
Turro Living, Wagner.

# Index / Indice

**Airon**  
pag. 10 - 17



**Antares Leg**  
pag. 80 - 85



**Antares Living**  
pag. 86 - 91



**Bolton**  
pag. 18 - 23



**Bresso**  
pag. 62 - 67



**Canaletto**  
pag. 92 - 97



**Cavour**  
pag. 38 - 43



**Claire**  
pag. 24 - 31



**Ghisolfa**  
pag. 74 - 79



**Manzoni Big**  
pag. 44 - 49



**Monforte**  
pag. 50 - 55



**Papillon**  
pag. 110 - 115



**Pisa**  
pag. 116 - 121



**Shelley**  
pag. 98 - 103





**Sirio**  
pag. 56 - 61



**Tiziano**  
pag. 32 - 37



**Turro Living**  
pag. 68 - 73



**Wagner**  
pag. 104 - 109



Un comfort sorprendente combinato con uno stile di design d'eccezione per la creazione di un prodotto inimitabile. La collezione Timeless raccoglie modelli essenziali ed iconici, realizzati con passione, perseveranza ed immaginazione che mescolano elementi di design con qualità e comfort.

*Amazing comfort combined with exceptional design style to create a inimitable product. The Timeless collection brings essential and iconic designs, made with passion, perseverance and imagination, that blend elements of with quality and comfort.*





# Airon

Comfort e volumi misurati caratterizzano il divano Airon. Il modello prevede diversi elementi che ne moltiplicano le possibilità di utilizzo. Lo schienale regolabile, per esempio, offre diverse opzioni di seduta: con sostegno più alto, ideale per conversare; comfort, perfetta per leggere; relax, più profonda, per la massima comodità.

*Comfort and volumes characterize the Airon sofa, with several sectional elements, providing more opportunities of forms and use. The backrest can be adjusted in various seating positions: with higher support, ideal for conversation; comfort, perfect for reading; rest moments, deeper seats, for maximum comfort.*







Airon in tessuto ONO 10.

*Airon in fabric ONO 10.*









Un comfort sorprendente combinato con uno stile di design d'eccezione per la creazione di un prodotto artigianale inimitabile. Airon in pelle ROYAL 2331.

*Amazing comfort combined with an exceptional design style to create a unique and incomparable handcraft product. Airon in leather ROYAL 2331.*



## Bolton

Perfetto per qualsiasi ambiente, il divano Bolton dotato di meccanismo poggiatesta a posizione variabile offre comfort e supporto ergonomico, arricchito da versioni terminali studiati nel dettaglio per trovare le più svariate collocazioni.

*Perfect for any environment, the Bolton sofa with variable position headrest mechanism offers comfort and ergonomic support, enriched with final versions designed in detail to find the most varied locations.*











Bolton in pelle ROYAL 2367.

*Bolton in leather ROYAL 2367.*



# Claire

Decisamente confortevole e molto elegante nella sua unicità. Claire è un divano dalle linee morbide e arrotondate, originale in ogni tipo di ambiente.

*Definitely comfortable and very elegant in its uniqueness. Claire is a sofa with soft and rounded lines, original in any environment.*







Claire in pelle NEVADA 2400.

*Claire in leather NEVADA 2400.*





Claire in tessuto OLO 15, con ripiano in marmo Emperador.

*Claire in fabric OLO 15, with Emperador marble.*







## Tiziano

Tiziano è un divano imponente. Si distingue per la presenza di poggiatesta reclinabili manualmente che ne incrementano il comfort. Le cuciture sulla seduta e i piedi alti e sottili donano un tocco di eleganza al modello. Disponibile in pelle o tessuto.

*The Tiziano is an impressive sofa. It is renowned for its manually reclining movement of the headrests that increases comfort. Moreover, the distinguishing stitching on the seat cushion and its tall and thin legs give this model a touch of elegance. Available in leather and fabric.*









Tiziano in tessuto IBO 56.

*Tiziano in fabric IBO 56.*





# Cavour

Caratterizzato da uno stile elegante e sofisticato, ne definiscono la linea originale, Cavour è l'ideale per un ambiente contemporaneo. Disponibile nella versione pelle o tessuto.

*Characterized by an elegant and sophisticated style it defines its original lines, the Cavour sofa is perfect for a contemporary environment. Available in leather and fabric.*







Cavour in tessuto OLO 02.

*Cavour in fabric OLO 02.*





## Manzoni Big

Il modello Manzoni Big è un divano imponente ed elegante, contornato da un delicato bordino in Gros Grain. La possibilità di regolare la profondità degli schienali, abbinata alla versione recliner, lo rendono pratico e confortevole.

*The Manzoni Big model is a massive and elegant sofa, surrounded by a delicate Gros Grain border. The possibility of adjusting the depth of the backs, combined with the reclining version, makes it a practical and comfortable product.*











Manzoni Big in pelle NEVADA 2401.

*Manzoni Big in leather NEVADA 2401.*



## Monforte

Monforte è un divano dall'estetica compatta e ordinata. Il bracciolo dalla forma trapezoidale attribuisce una nota di originalità al modello, mentre la presenza del meccanismo pendular gli conferisce dinamicità ampliandone il comfort. Disponibile in pelle o tessuto.

*The Monforte is a sofa with a compact, tidy look. The trapezoidal shape of the armrest gives the model an original style, while its pendular mechanism gives it dynamism and enhances comfort. Available in leather and fabric.*







Monforte in pelle COLORADO 2553.

*Monforte in leather COLORADO 2553.*







## Sirio

Semplice e geometrico, il modello Sirio è ideale in ambienti moderni. I disegni verticali creati dalle cuciture artigianali lo rendono unico. Disponibile in pelle o tessuto.

*Simple and geometric, the Sirio model is ideal in modern environments. The vertical designs created by the handmade stitching make it unique. Available in leather or fabric.*









Sirio in tessuto ONO 06 con laccetti fibbia in pelle NEVADA 2412.

*Sirio in fabric ONO 06 with buckle straps in leather NEVADA 2412.*





## Bresso

Un sistema di sedute dal carattere giovane e dinamico, nel quale elementi dalle forme geometriche compongono un originale gioco di morbidi volumi, seguendo un ritmo anticonvenzionale di pieni e vuoti.

*Dynamic seating system where geometric lines form an original mix of soft volumes in an unconventional rhythm of full and empty spaces.*







Gli schienali mobili, ma al tempo stesso stabili, conferiscono al modello Bresso un design dinamico consentendo di comporre il divano a proprio piacimento.

*The movable yet stable backrests lend the Bresso model a dynamic design that allows you to arrange the sofa as you please.*





## Turro Living

Dalle curve morbide e dall'eccezionale comfort di seduta, il Turro Living si adatta facilmente alla location classica e moderna a seconda del rivestimento. I piedi in metallo, con puntale in oro, conferiscono una nota di classe. Disponibile in pelle e tessuto.

*With its soft curves and exceptional seating comfort, the Turro Living can easily be adapted to both classic and modern locations, depending on the covering. The metal legs, with a gold end cap, add a touch of elegance. Available in leather and fabric.*











Turro Living in velluto VEG 44.

*Turro Living in velvet VEG 44.*



## Ghisolfa

Il bracciolo sottile delimitato da una cerniera, conferiscono al Ghisolfa un aspetto davvero trendy. Accessori come il tavolino in marmo e il poggiatesta gli donano anche uno stile originale e singolare.

*The slim armrest bordered by a zip give to the Ghisolfa sofa a truly trendy look. Accessories such as marble coffee table and headrest also give it an original and unique style.*











Ghisolfa in tessuto ONO 03.

*Ghisolfa in fabric ONO 03.*



## Antares Leg

Un modello senza tempo, dalle linee semplici, attuali, estremamente versatile, ideale per ogni living. Caratteristica del modello Antares è il movimento dello schienale e della seduta che permettono di raggiungere il massimo comfort e i dettagli delle impunture che sottolineano la forma del divano.

*A timeless model with simple lines, extremely versatile, ideal for any living room. The movement of the backrest and seat allow maximum comfort and characterize the model Antares, also the stitching details that emphasize the shape of this sofa.*









Antares Leg in tessuto IBO 26.

*Antares Leg in fabric IBO 26.*





## Antares Living

Un modello senza tempo, dalle linee semplici, attuali, estremamente versatile, ideale per ogni living. Caratteristica del modello Antares è il movimento dello schienale e della seduta che permettono di raggiungere il massimo comfort e i dettagli delle impunture che sottolineano la forma del divano.

*A timeless model with simple lines, extremely versatile, ideal for any living room. The movement of the backrest and seat allow maximum comfort and characterize the model Antares, also the stitching details that emphasize the shape of this sofa.*







Antares Living diventa protagonista di ogni casa, si contraddistingue per le sue linee essenziali e il suo design moderno. Antares Living in pelle ROYAL 2367.

*Antares Living becomes protagonist of living spaces. It is characterized by essential lines and modern design. Antares Living in leather ROYAL 2367.*





## Canaletto

Funzionalità e forme si fondono in armonia. Il Canaletto è un divano imponente, ideale in grandi ambienti. È dotato di poggiatesta regolabili a mano o di meccanismo reclining. Disponibile in pelle o tessuto.

*Form and functionality merge in perfect harmony. The Canaletto is an impressive sofa, ideal for spacious settings. It is equipped with manually adjustable headrests or a reclining mechanism. Available in leather and fabric.*









Canaletto in pelle COLORADO 2557.

*Canaletto in leather COLORADO 2557.*





# Shelley

Originale, smart, glamour. Shelley è il divano progettato per ambienti moderni. Corredato da una libreria in legno integrata al bracciolo è perfetto per gli amanti della lettura. Disponibile in pelle o tessuto.

*Original, smart and glamorous. The Shelley model is designed for modern environments. Featuring a wooden bookcase integrated into the armrest, it is perfect for reading lovers. Available in leather and fabric.*







Shelley in pelle COLORADO 2562.

*Shelley in leather COLORADO 2562.*







## Wagner

Il pannello e le cuciture sul cuscino di schienale rafforzano il profilo del modello Wagner e permettono di creare abbinamenti personalizzati e nuovi. Il movimento dello schienale permette di raggiungere il massimo comfort.

*The panel and stitching on the cushions back characterize the wagner model and allow new combinations. The movement of the backrest allows maximum comfort.*









Wagner in pelle ROYAL 2359.

*Wagner in leather ROYAL 2359.*





# Papillon

Accogliente, raffinato ed informale al tempo stesso. Il modello Papillon presenta una linea versatile che gli consente di inserirsi con stile ed eleganza in qualunque ambiente.

*Welcoming, refined and informal at the same time. The Papillon has a versatile design that allows it to fit in with style and elegance in any environment.*









Papillon in tessuto OCO 11.

*Papillon in fabric OCO 11.*



## *Pisa*

Pisa coniuga alle linee pulite ed essenziali una promessa di calda accoglienza e grande morbidezza. I cuscini schienale garantiscono una sensazione di avvolgente morbidezza e sono mobili per ottenere risultati differenti sia sul piano estetico che ergonomico.

*Pisa combines clean, essential lines with a promise of warmth and softness. The backrest cushions guarantee a soft, enveloping feeling and can be moved to achieve different aesthetic and ergonomic results.*









Pisa in pelle ROYAL 2337.

*Pisa in leather ROYAL 2337.*



Descrizione foto e  
disegni tecnici

*Photo description and  
Technical Sheets*

**Note** | I colori e le textures di pelle e tessuti sono da considerarsi puramente indicativi in quanto potrebbero esserci variazioni di colori, effetti rispetto alla realtà. Si prega di far riferimento al campionario rivestimenti.

**Notes** | The colors and textures of leather and fabrics are to be considered purely indicative as they could be variations of colors, effects compared to reality. Please refer to the samples to select them.





## AIRON p.12-13

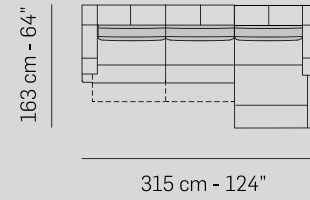

### Divano Airon (Cod.3462+5201)

Tessuto | Ono Col.10 Cat.D - Italia Collection  
Piedi | metallo Bronzo Anticato (Cod.52)

### Cuscini

CU57 Tessuto | Ibo Col.04 Cat.D - Flair Collection  
CU68 Tessuto | Ibo Col.04 Cat.D - Flair Collection

### Tavolino Metrico (Cod.9502)

Ripiano | marmo Emperador (Cod.EM)  
Struttura | metallo Bronzo Anticato (Cod.52)

### Airon sofa (Cod.3462+5201)

Fabric | Ono Col.10 Cat.D - Italia Collection  
Legs | Antique Bronze metal (Cod.52)

### Pillows

CU57 Fabric | Ibo Col.04 Cat.D - Flair Collection  
CU68 Fabric | Ibo Col.04 Cat.D - Flair Collection

### Metrico coffee table (Cod.9502)

Top | Emperador marble (Cod.EM)  
Structure | Antique Bronze metal (Cod.52)



## ANTARES LEG p.82-83

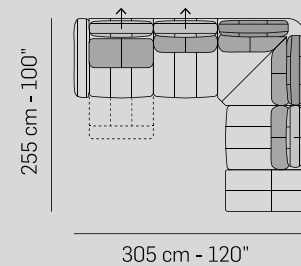

### Divano Antares Leg (Cod.3432+4405+1601)

Tessuto | Ibo Col.26 Cat.D - Flair Collection  
Piedi | metallo Bronzo Anticato (Cod.52)

### Cuscini

CU57 Tessuto | Ibo Col.26 Cat.D - Flair Collection  
CU57 Tessuto | Imi Col.17 Cat.G - Atelier Collection

### Antares Leg sofa (Cod.3432+4405+1601)

Fabric | Ibo Col.26 Cat.D - Flair Collection  
Legs | Antique Bronze metal (Cod.52)

### Pillows

CU57 Fabric | Ibo Col.26 Cat.D - Flair Collection  
CU57 Fabric | Imi Col.17 Cat.G - Atelier Collection



## ANTARES LIVING p.88-89

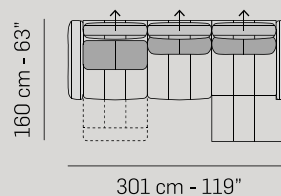

### Divano Antares Living (Cod.3432\*5201)

Pelle | Royal 2337 Cat.2000  
Piedi | metallo Bronzo Anticato (Cod.52)

### Cuscino

CU57 Tessuto | Reg Col.59 Cat.G - Pure Velvet Collection

### Tavolino Metrico (Cod. 9502)

Ripiano | marmo Emperador (Cod.EM)  
Struttura | metallo Bronzo Anticato (Cod.52)

### Antares Living sofa (Cod.3432\*5201)

Leather | Royal 2337 Cat.2000  
Legs | Antique Bronze metal (Cod.52)

### Pillow

CU57 Fabric | Reg Col.59 Cat.G - Pure Velvet Collection

### Metrico coffee table (Cod.9502)

Top | Emperador marble (Cod.EM)  
Structure | Antique Bronze metal (Cod.52)



## BOLTON p.20-21

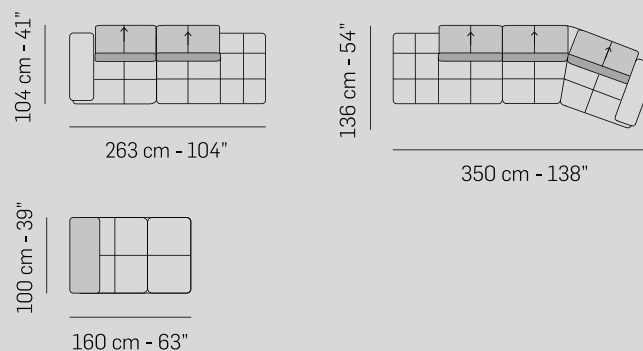

### Divano Bolton (Cod.1202\*1601\*1602\*3091) (Cod.6033)

(Cod.1202\*1601\*1602\*3091) Tessuto | Olo Col.03 Cat.G - Atelier Collection  
Piedi | metallo Bronzo Anticato (Cod.52)

(Cod.6033) Rivestimento mix | Tessuto: Olo Col.03 Cat.G - Atelier Collection - Pelle: Colorado 2553 Cat.2500  
Piedi | metallo Bronzo Anticato (Cod.52)

### Cuscini

CU57 n° 2 Pelle | Colorado 2553 Cat.2500  
CU58 Tessuto | Olo Col.11 Cat.G - Atelier Collection  
CU68 Tessuto | Olo Col.11 Cat.G - Atelier Collection

### Bolton sofa (Cod.1202\*1601\*1602\*3091) (Cod.6033)

(Cod.1202\*1601\*1602\*3091) Fabric | Olo Col.03 Cat.G - Atelier Collection  
Legs | Antique Bronze metal (Cod.52)

(Cod.6033) Combined covering | Fabric: Olo Col.03 Cat.G - Atelier Collection - Leather: Colorado 2553 Cat.2500  
Legs | Antique Bronze metal (Cod.52)

### Pillows

CU57 n° 2 Leather | Colorado 2553 Cat.2500  
CU58 Fabric | Olo Col.11 Cat.G - Atelier Collection  
CU68 Fabric | Olo Col.11 Cat.G - Atelier Collection



## BRESSO p.64-65

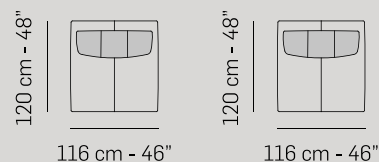

### Divano Bresso (Cod.1203+1203)

Tessuto/Pelle | Rivestimento primario e anteriore schienale: Lir Col.26  
Cat.D - Flair Collection - Retro schienale: Diamond 4179 Cat.4000  
Piedi | Ral 9005

### Cuscini

CU72 Pelle | Diamond 4179 Cat.4000  
CU68 Pelle | Diamond 4179 Cat.4000

### Tavolino Grancircolo (Cod.9502)

Ripiano | marmo Emperador (Cod.EM)  
Struttura | metallo Canna di Fucile (Cod.50)

### Tavolino Circolo (Cod.9502)

Ripiano | marmo Emperador (Cod.EM)  
Struttura | metallo Canna di Fucile (Cod.50)

### Bresso sofa (Cod.1203+1203)

Fabric/Leather | Primary covering and frontal part of backrest: Lir Col.26  
Cat.D - Flair Collection - Back part of backrest: Diamond 4179 Cat.4000  
Legs | Ral 9005

### Pillows

CU72 Leather | Diamond 4179 Cat.4000  
CU68 Leather | Diamond 4179 Cat.4000

### Grancircolo coffee table (Cod.9502)

Top | Emperador marble (Cod.EM)  
Structure | Gunmetal (Cod.50)

### Circolo coffee table (Cod.9502)

Top | Emperador marble (Cod.EM)  
Structure | Gunmetal (Cod.50)



## CANALETTO p.94-95

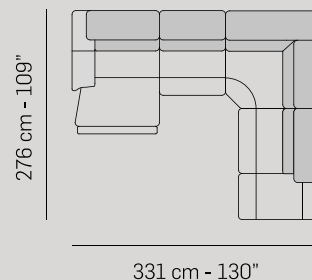

### Divano Canaletto (Cod.3632+4404+1601)

Pelle | Colorado 2555 Cat.2500  
Piedi | metallo Canna di Fucile (Cod.50)

### Tavolino Metrico (Cod.9502)

Ripiano | marmo Emperador (Cod.EM)  
Struttura | metallo Canna di Fucile (Cod.50)

### Tavolino Fly Small (Cod.9502)

Ripiano | metallo Ottone satinato (Cod.51)  
Struttura | metallo Ottone satinato (Cod.51)

### Canaletto sofa (Cod.3632+4404+1601)

Leather | Colorado 2555 Cat.2500  
Legs | Gunmetal (Cod.50)

### Metrico coffee table (Cod.9502)

Top | Emperador marble (Cod.EM)  
Structure | Gunmetal (Cod.50)

### Fly Small coffee table (Cod.9502)

Top | Satin Brass metal (Cod.51)  
Structure | Satin Brass metal (Cod.51)





CAVOUR p.40-41

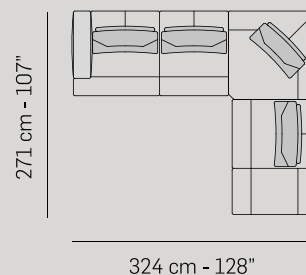

**Divano Cavour (Cod.3002+4304+1601)**

Pelle | Nobile 3058 Cat.3000  
Piedi | metallo Canna di Fucile (Cod.50)

**Cuscini**

CU50 Tessuto | Reg Col.70 Cat.G - Pure Velvet Collection  
CU57 Tessuto | Coc Col.12 Cat.G - Atelier Collection

**Cavour sofa (Cod.3002+4304+1601)**

Leather | Nobile 3058 Cat.3000  
Legs | Gunmetal (cod.50)

**Pillows**

CU50 Fabric | Reg Col.70 Cat.G - Pure Velvet Collection  
CU57 Fabric | Coc Col.12 Cat.G - Atelier Collection



CLAIRE p.26-27

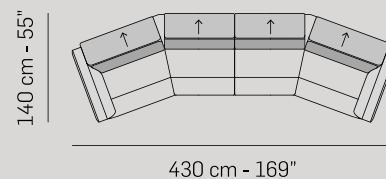

**Divano Claire (Cod.3092+3091)**

Pelle | Nevada 2407 Cat.2000  
Piedi | metallo Bronzo Anticato (Cod.52)

**Cuscino**

CU58 Tessuto | Olo Col.13 Cat.G - Atelier Collection

**Poltrona Diga Swivel (Cod.1360)**

Pelle/Tessuto | Scocca: Colorado 2551 Cat.2500 - Cuscini di seduta e spalliera: Olo Col.15 Cat.G - Atelier Collection  
Base girevole | metallo Bronzo Anticato (Cod.52)

**Tavolino Round (Cod.9502)**

Ripiano | marmo Emperador (Cod.EM)  
Struttura | metallo Bronzo Anticato (Cod.52)

**Tavolino Circolo (Cod.9502)**

Ripiano | marmo Emperador (Cod.EM)  
Struttura | metallo Bronzo Anticato (Cod.52)

**Claire sofa (Cod.3092+3091)**

Leather | Nevada 2407 Cat.2000  
Legs | Antique Bronze metal (Cod.52)

**Pillow**

CU58 Fabric | Olo Col.13 Cat.G - Atelier Collection

**Diga Swivel armchair (Cod.1360)**

Leather/Fabric | Frame: Colorado 2551 Cat.2500 - Seat and back cushions: Olo Col.15 Cat.G - Atelier Collection  
Swivel base | Antique Bronze metal (Cod.52)

**Round coffee table (Cod.9502)**

Top | Emperador marble (Cod.EM)  
Structure | Antique Bronze metal (Cod.52)

**Circolo coffee table (Cod.9502)**

Top | Emperador marble (Cod.EM)  
Structure | Antique Bronze metal (Cod.52)



## GHISOLFA p.76-77

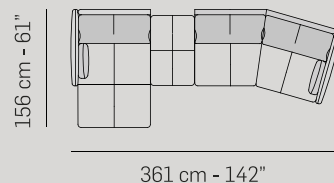
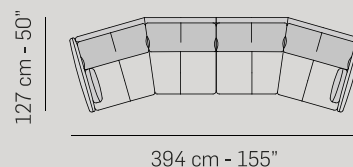

**Divano Ghisolfa (Cod.3092+3091) (3091+8135+5202+9900)**  
**(Cod.3092+3091)** Pelle | Nevada 2415 Cat.2000  
 Piedi | metallo Bronzo Anticato (Cod.52) con parte inferiore verniciata in Oro Satinato  
**(Cod.3091+8135+5202+9900)** Tessuto | Ono Col.03 Cat.D - Italia Collection  
 Piedi | metallo Bronzo Anticato (Cod.52) con parte inferiore verniciata in Oro Satinato

### Cuscini

CU58 Tessuto | Reg Col.46 Cat.G - Pure Velvet Collection  
 CU58 Tessuto | Dod Col.37 Cat.G - Tech Velvet Collection  
 CU68 Tessuto | Dod Col.37 Cat.G - Tech Velvet Collection

### Tavolino Metrico (Cod.9502)

Ripiano | marmo Emperador (Cod.EM)  
 Struttura | metallo Bronzo Anticato (Cod.52)

### Tavolino Metrico Small (Cod.9502)

Ripiano | marmo Emperador (Cod.EM)  
 Struttura | metallo Bronzo Anticato (Cod.52)

**Ghisolfa sofa (Cod.3092+3091) (3091+8135+5202+9900)**  
**(Cod.3092+3091)** Leather | Nevada Col.2415 Cat.2000  
 Legs | Antique Bronze metal (Cod.52) with lower part painted in Matte Gold color  
**(Cod.3091+8135+5202+9900)** Fabric | Ono Col.03 Cat.D - Italia Collection  
 Legs | Antique Bronze metal (Cod.52) with lower part painted in Matte Gold color

### Pillows

CU58 Fabric | Reg Col.46 Cat.G - Pure Velvet Collection  
 CU58 Fabric | Dod Col.37 Cat.G - Tech Velvet Collection  
 CU68 Fabric | Dod Col.37 Cat.G - Tech Velvet Collection

### Metrico coffee table (Cod.9502)

Top | Emperador marble (Cod.EM)  
 Structure | Antique Bronze metal (Cod.52)

### Metrico Small coffee table (Cod.9502)

Top | Emperador marble (Cod.EM)  
 Structure | Antique Bronze metal (Cod.52)



## MANZONI BIG p.46-47

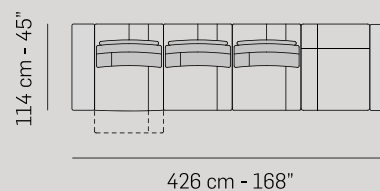

**Divano Manzoni Big (Cod.B1162+1203+1203+B8041)**  
**(Cod.B1162+1203+1203)** Tessuto | Ono Col.10 Cat.D - Italia Collection- con bordino Gros Grain Col.037 - Piedi | metallo Canna di Fucile (Cod.50)  
**(Cod.B8041)** Tessuto | Reg Col.46 Cat.G - Pure Velvet Collection - con bordino Gros Grain Col.037 - Piedi | Ral 9005

### Cuscini

CU58 Tessuto | Reg Col.46 Cat.G - Pure Velvet Collection  
 CU68 Tessuto | Ono Col.10 Cat.D - Italia Collection

### Tavolino Metrico (Cod.9502)

Ripiano | marmo Emperador (Cod.EM)  
 Struttura | metallo Bronzo Anticato (Cod.52)

### Tavolino Fly Small (Cod.9502)

Ripiano | metallo Bronzo Anticato (Cod.52)  
 Struttura | metallo Bronzo Anticato (Cod.52)

### Tavolino Fly (Cod.9502)

Ripiano | metallo Bronzo Anticato (Cod.52)  
 Struttura | metallo Bronzo Anticato (Cod.52)

**Manzoni Big sofa (Cod.B1162+1203+1203+B8041)**  
**(Cod.B1162+1203+1203)** Fabric | Ono Col.10 Cat.D - Italia Collection - with piping in Gros Grain Col.037 - Legs | Gun metal (cod.50)  
**(Cod.B8041)** Fabric | Reg Col.46 Cat.G - Pure Velvet Collection - with piping in Gros Grain Col.037 - Legs | Ral 9005

### Pillows

CU58 Fabric | Reg Col.46 Cat.G - Pure Velvet Collection  
 CU68 Fabric | Ono Col.10 Cat.D - Italia Collection

### Metrico coffee table (Cod.9502)

Top | Emperador marble (Cod.EM)  
 Structure | Antique Bronze metal (Cod.52)

### Fly Small coffee table (Cod.9502)

Top | Antique Bronze metal (Cod.52)  
 Structure | Antique Bronze metal (Cod.52)

### Fly coffee table (Cod.9502)

Top | Antique Bronze metal (Cod.52)  
 Structure | Antique Bronze metal (Cod.52)



## MONFORTE p.52-53

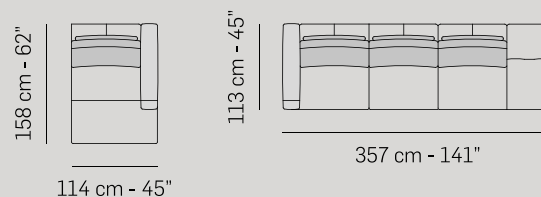

**Divano Monforte (Cod.3002+1601) (Cod.5201)**  
**(Cod.3002+1601)** Pelle | Diamond 4180 Cat.4000  
**(Cod.5201)** Tessuto | Oco Col.16 Cat.D - Flair Collection  
 Piedi | metallo Canna di Fucile (Cod.50)

**Poltrona Rondò (Cod.1000+9010) n° 2**  
 Pelle | Diamond 4180 Cat.4000  
 Piede | Legno rivestito in pelle Diamond 4180 Cat.4000

**Tavolino Metrico (Cod.9502)**  
 Ripiano | marmo Bianco Carrara (Cod.CA)  
 Struttura | metallo Canna di Fucile (Cod.50)

**Monforte sofa (Cod.3002+1601) (Cod.5201)**  
**(Cod.3002+1601)** Leather | Diamond 4180 Cat.4000  
**(Cod.5201)** Fabric | Oco Col.16 Cat.D - Flair Collection  
 Legs | Gunmetal (Cod.50)

**Rondò armchair (Cod.1000+9010) n° 2**  
 Leather | Diamond 4180 Cat.4000  
 Legs | Wooden legs covered in leather Diamond 4180 Cat.4000

**Metrico coffee table (Cod.9502)**  
 Top | White Carrara marble (Cod.CA)  
 Structure | Gunmetal (Cod.50)



## PAPILLON p.112-113

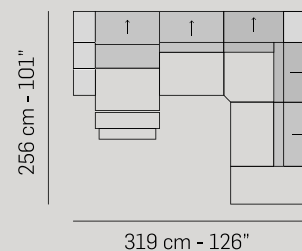

**Divano Papillon (Cod.3432+4404+1601)**  
 Pelle | Colorado 2553 Cat.2500  
 Piedi | metallo Canna di Fucile (Cod.50)

**Cuscini**  
 CU57 Tessuto | Veg Col.45 Cat.G - Cloudy Velvet Collection  
 CU57 Tessuto | Coc Col.08 Cat.G - Atelier Collection

**Tavolino Metrico (Cod.9502)**  
 Ripiano | marmo Emperador (Cod.EM)  
 Struttura | metallo Bronzo Anticato (Cod.52)

**Papillon sofa (Cod.3432+4404+1601)**  
 Leather | Colorado 2553 Cat.2500  
 Legs | Gunmetal (Cod.50)

**Pillows**  
 CU57 Fabric | Veg Col.45 Cat.G - Cloudy Velvet Collection  
 CU57 Fabric | Coc Col.08 Cat.G - Atelier Collection

**Metrico coffee table (Cod.9502)**  
 Top | Emperador marble (Cod.EM)  
 Structure | Antique Bronze metal (Cod.52)



PISA p.118-119

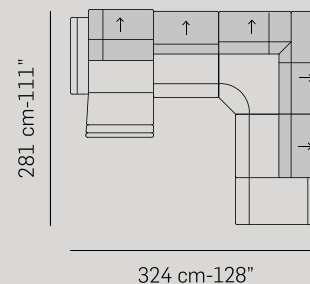

**Divano Pisa (Cod.3632\*4404\*1601)**

Pelle | Royal Col.2341 Cat.2000  
Piedi | metallo Bronzo Anticato (Cod.52)

**Cuscini**

CU57 Tessuto | Olo Col.13 Cat.G - Atelier Collection  
CU68 Tessuto | Dod Col.32 Cat.G - Tech Velvet Collection

**Pisa sofa (Cod.3632\*4404\*1601)**

Leather | Royal Col.2341 Cat.2000  
Legs | Antique Bronze metal (Cod.52)

**Pillows**

CU57 Fabric | Olo Col.13 Cat.G - Atelier Collection  
CU68 Fabric | Dod Col.32 Cat.G - Tech Velvet Collection



SHELLEY p.100-101

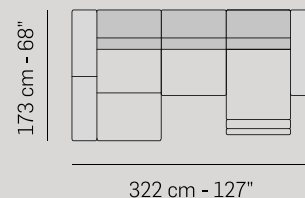

**Shelley sofa (Cod.5202\*3631)**

Pelle | Colorado 2562 Cat.2500  
Libreria interno bracciolo | legno verniciato nel colore RAL 7024 opaco  
Piedi | metallo Canna di Fucile (Cod.50)

**Cuscini**

CU57 Tessuto | Mio Col.05 Cat.G - Atelier Collection  
CU57 Tessuto | Olo Col.21 Cat.G - Atelier Collection  
CU68 Tessuto | Mio Col.05 Cat.G - Atelier Collection

**Poltrona Rho (Cod.1000)**

Tessuto | Mio Col.05 Cat.G - Atelier Collection  
Piede | metallo Canna di Fucile (Cod.50)

**Tavolino Fly (Cod.9502)**

Ripiano | metallo Ottone Satinato (Cod.51)  
Struttura | metallo Ottone satinato (Cod.51)

**Shelley sofa (Cod.5202\*3631)**

Leather | Colorado 2562 Cat.2500  
Armrests with bookcase | wood painted in color RAL 7024 matte  
Legs | Gunmetal (Cod.50)

**Pillows**

CU57 Fabric | Mio Col.05 Cat.G - Atelier Collection  
CU57 Fabric | Olo Col.21 Cat.G - Atelier Collection  
CU68 Fabric | Mio Col.05 Cat.G - Atelier Collection

**Rho armchair (Cod.1000)**

Fabric | Mio Col.05 Cat.G - Atelier Collection  
Legs | Gunmetal (Cod.50)

**Fly coffee table (Cod.9502)**

Top | Satin Brass metal (Cod.51)  
Structure | Satin Brass metal (Cod.51)



SIRIO p.58-59

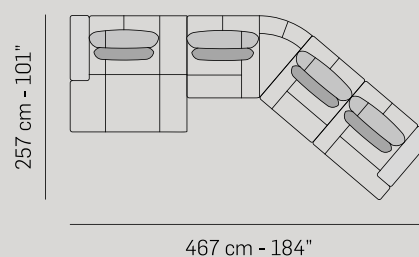

**Divano Sirio (Cod.5232\*1841\*3001)**

Pelle | Colorado 2552 Cat.2500  
Piedi | Canna di Fucile (Cod.50)

**Poltrona Julie (Cod.1360) n° 2**

Tessuto | Por Col.01 Cat.G - Atelier Collection  
Base girevole | Legno finitura nero

**Tavolino Grancircolo (Cod.9502)**

Ripiano | marmo Nero Marquinia (Cod.NM)  
Struttura | Canna di Fucile (Cod.50)

**Tavolino Round (Cod.9502)**

Ripiano | marmo Bianco Carrara (Cod.CA)  
Struttura | metallo Canna di Fucile (Cod.50)

**Sirio sofa (Cod.5232\*1841\*3001)**

Leather | Colorado 2552 Cat.2500  
Legs | Gunmetal (Cod.50)

**Julie armchair (Cod.1360) n° 2**

Fabric | Por Col.01 Cat.G - Atelier Collection  
Swivel base | Wooden base in black color

**Grancircolo coffee table (Cod.9502)**

Top | Black Marquinia marble (Cod.NM)  
Structure | Gunmetal (Cod.50)

**Round coffee table (Cod.9502)**

Top | White Carrara marble (Cod.CA)  
Structure | Gunmetal (Cod.50)



TIZIANO p.34-35

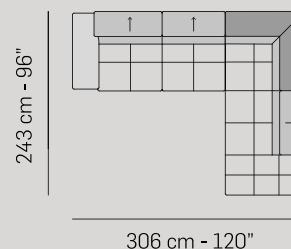

**Divano Tiziano (Cod.3202\*4231)**

Pelle | Royal Col.2354 Cat.2000  
Piedi | metallo Canna di Fucile (Cod.50)

**Cuscini**

CU58 Tessuto | Lir Col.24 Cat.D - Flair Collection  
CU68 Tessuto | Lir Col.24 Cat.D - Flair Collection  
CU57 Tessuto | Lir Col.24 Cat.D - Flair Collection

**Poltrona Stresa (Cod.1000)**

Tessuto | Veg Col.53 Cat.G - Cloudy Velvet Collection  
Piedi | Legno finitura Wengè (Cod.05)

**Tavolino Metrico (Cod.9502)**

Ripiano | marmo Emperador (Cod.EM)  
Struttura | metallo Canna di Fucile (Cod.50)

**Tavolino Circolo (Cod.9502)**

Ripiano | marmo Emperador (Cod.EM)  
Struttura | metallo Canna di Fucile (Cod.50)

**Tiziano sofa (Cod.3202\*4231)**

Leather | Royal Col.2354 Cat.2000  
Legs | Gunmetal (Cod.50)

**Pillows**

CU58 Fabric | Lir Col.24 Cat.D - Flair Collection  
CU68 Fabric | Lir Col.24 Cat.D - Flair Collection  
CU57 Fabric | Lir Col.24 Cat.D - Flair Collection

**Stresa armchair (Cod.1000)**

Fabric | Veg Col.53 Cat.G - Cloudy Velvet Collection  
Legs | Wooden legs in Wengè (Cod.05)

**Metrico coffee table (Cod.9502)**

Top | Emperador marble (Cod.EM)  
Structure | Gunmetal (Cod.50)

**Circolo coffee table (Cod.9502)**

Top | Emperador marble (Cod.EM)  
Structure | Gunmetal (Cod.50)



## TURRO LIVING p.70-71

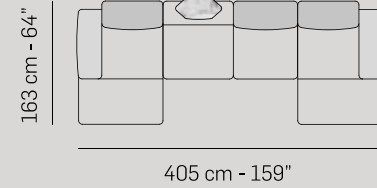

### Divano Turro Living (Cod.5202+1702+5201+9503)

Pelle | Colorado 2553 Cat.2500  
 Piedi | metallo Canna di Fucile (Cod.50) con parte inferiore verniciata in colore Oro satinato  
 Accessorio Tavolino Terminale (Cod.9503) - Ripiano | marmo Emperador (Cod.EM) - Struttura | metallo Canna di Fucile (Cod.50)

### Cuscini

CU58 Tessuto | Olo Col.20 Cat.G - Atelier Collection  
 CU58 Tessuto | Coc Col.08 Cat.G - Atelier Collection

### Poltrona Bonola (Cod.1000)

Pelle/Tessuto | Scocca e poggiatesta: Nabuk 5009 Cat.5000 - Cuscini di seduta e spalliera: Olo Col.20 Cat.G - Atelier Collection  
 Piede | Legno finitura Wengè (Cod.05)

### Tavolino Round (Cod.9502)

Ripiano | marmo Emperador (Cod.EM)  
 Struttura | metallo Canna di Fucile (Cod.50)

### Tavolino Circolo (Cod.9502)

Ripiano | marmo Emperador (Cod.EM)  
 Struttura | metallo Canna di Fucile (Cod.50)

### Turro Living sofa (Cod.5202+1702+5201+9503)

Leather | Colorado 2553 Cat.2500  
 Legs | Gunmetal (Cod.50) with lower part painted in Matte Gold color  
 Optional terminal table (Cod.9503) - Top | Emperador marble (Cod.EM) - Structure | Gunmetal (Cod.50)

### Pillows

CU58 Fabric | Olo Col.20 Cat.G - Atelier Collection  
 CU58 Fabric | Coc Col.08 Cat.G - Atelier Collection

### Bonola armchair (Cod.1000)

Leather/Fabric | Frame and headrest: Nabuk 5009 Cat.5000 - Seat and back cushions: Olo Col.20 Cat.G - Atelier Collection  
 Legs | Wooden legs in Wengè (Cod.05)

### Round coffee table (Cod.9502)

Top | Emperador marble (Cod.EM)  
 Structure | Gunmetal (Cod.50)

### Circolo coffee table (Cod.9502)

Top | Emperador marble (Cod.EM)  
 Structure | Gunmetal (Cod.50)



## WAGNER p.106-107

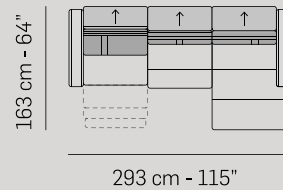

### Wagner (Cod.3432+5201)

Tessuto | Olo Col.02 Cat.G - Atelier Collection  
 Piedi | metallo Bronzo Anticato (Cod.52)

### Wagner (Cod.3432+5201)

Fabric | Olo Col.02 Cat.G - Atelier Collection  
 Legs | Antique Bronze metal (Cod.52)



# AIRON

Design Application N° 008642821-0001



Frontale/Front



Laterale/Depth

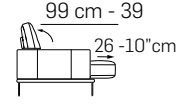
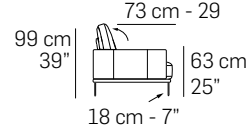
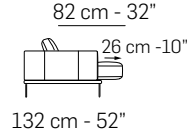
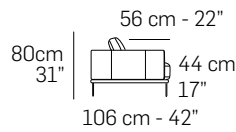

## Caratteristiche standard

- Struttura in legno e multistrato, molleggio seduta con cinghie elastiche.
- Imbottiture in poliuretano espanso ecologico a cellula aperta con densità differenziate.
- Rivestimento in pelle o tessuto. Cuscino di schienale sfoderabile per entrambi.
- Piede in metallo Canna di fucile (Cod.50), Bronzo anticato (Cod.52).
- Cuscini di schienale dotati di meccanismo manuale che permette il sollevamento dello stesso aumentando la sua altezza di 19 cm e la profondità della seduta di 17 cm.
- Cuscini di seduta (esclusi CL e pouf) dotati di meccanismo manuale a scorrimento che aumenta la profondità di seduta di 26 cm.
- Cuciture Cod.01 + Cod.03 per rivestimento in pelle.
- Cuciture Cod.03 per rivestimento in tessuto.
- Inserimento letto non possibile.
- Lato componibile non rifinito.

## Caratteristiche optional su richiesta senza maggiorazione

- Disponibile con cucitura a contrasto. Per la scelta del colore fare riferimento ai codici del campionario pelli.

## Caratteristiche optional su richiesta con maggiorazione

- Per il multi rivestimento il prezzo va incrementato del 7%. Per maggiori dettagli fare riferimento al paragrafo "NOTE" posto nelle prime pagine del listino.

## Note

- Il movimento dello schienale combinato a quello della seduta, permette di ottenere una profondità di seduta di ben 99 cm.
- Non è possibile applicare altre cuciture.
- Per alcuni tessuti e velluti l'azienda si riserva di applicare la cucitura Cod.00 / Cod.03 (vedi immagine).

## Standard features

- Frame: wooden structure, seat suspensions in reinforced elastic webbing.
- Paddings in eco-friendly open cell polyurethane foam with different densities.
- Covering in leather or fabric. Back cushion coverings removable.
- Legs in Gunmetal (Cod.50), Antique Bronze (Cod.52).
- Manual mechanism for backrest cushions that allows it to be raised, increasing its height by 19 cm and the depth of the seat by 17 cm.
- Seat cushions (except CL and pouf) have a manual sliding mechanism that increases the seat depth by 26 cm.
- Stitchings type Cod.01 + Cod.03 for leather covering.
- Stitching type Cod.03 for fabric covering.
- No bed version available.
- Sectional sides not finished.

## Optional features without any upcharge

- Stitching, unless differently requested, will be matching the leather or fabric colour. Contrast stitching colour can be ordered at no extra charge. You might use as reference any Nicoline leather.

## Optional features with upcharge

- 7% upcharge for combined coverings. Please refer to the notes at the beginning of pricelist.

## Notes

- Backrest movement combined with that of the seat allows the seat depth to be by 99 cm.
- Different stitchings not available.
- For some fabrics and velvets production dept. must apply the stitching Cod.00 / Cod.03 (as per picture below).



Canna di Fucile (Cod.50) //  
Gunmetal (Cod.50)



Bronzo Anticato (Cod.52) //  
Antique Bronze (Cod.52)

Piede in metallo //  
Metal leg

Cuciture //  
Stitching

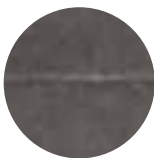

Cod.00

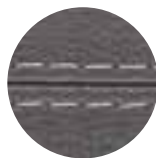

Cod.01

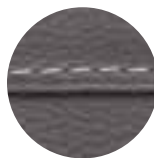

Cod.03



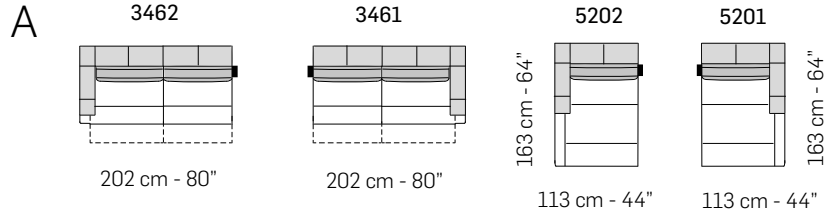
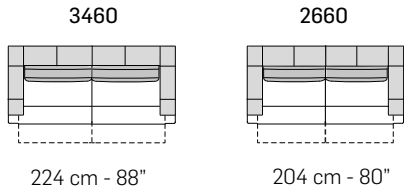

tutti gli elementi del gruppo A hanno lo stesso modulo di seduta - all items in group A have the same seat width

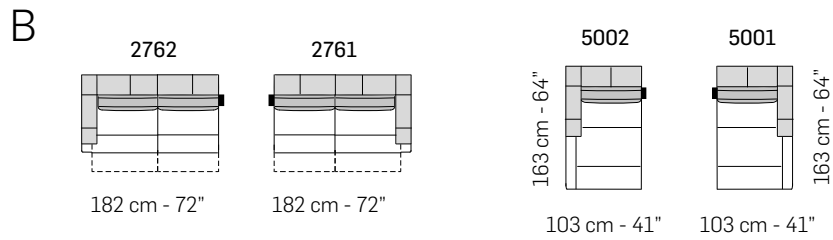

tutti gli elementi del gruppo B hanno lo stesso modulo di seduta - all items in group B have the same seat width

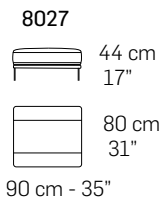

COMPOSIZIONI CONSIGLIATE / SUGGESTED COMPOSITIONS

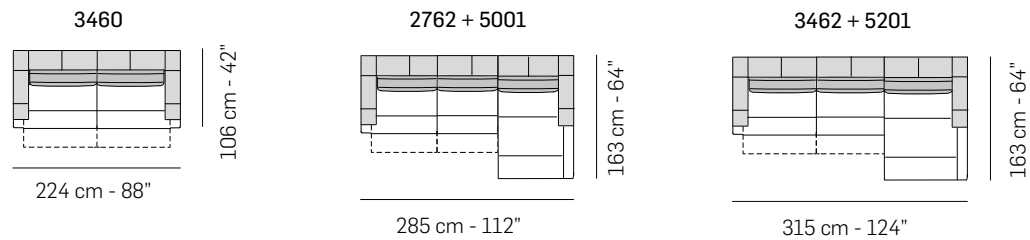

Scala 1:100  
Ratio 1 to 100

Legenda / Legend

- Spalliera / Back Cushions
- Bracciolo / Armrest
- Poggiareni / Kidneyrest
- Seduta / Seat Cushions
- Aggancio Componibile / Connector

Note / Notes

Nicoline si riserva il diritto di apportare in ogni momento modifiche tecniche ed estetiche / Nicoline reserves the right to change, at any time and without prior warning, technical and aesthetic specifications of the articles.

# ANTARES LEG

Design Application N° 402020000002749

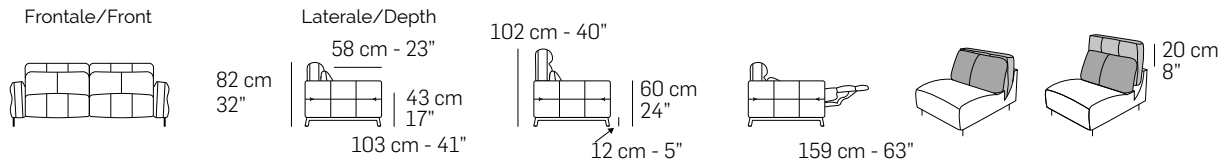

### Caratteristiche standard

- Struttura in legno e multistrato, molleggio seduta e schienale con cinghie elastiche.
- Imbottiture in poliuretano espanso ecologico a cellula aperta con densità differenziate.
- Rivestimento in pelle o tessuto. Tutti i rivestimenti sono fissi.
- Piede in metallo Canna di fucile (Cod.50), Bronzo anticato (Cod.52).
- Versioni fisse con meccanismo poggiatesta elettrico che aumenta l'altezza dello stesso di cm 20.
- Versioni recliner con meccanismo elettrico sia per la seduta che per il poggiatesta.
- Tutte le versioni contrassegnate dal simbolo "↑", sono dotate di poggiatesta regolabile elettricamente.
- Cucitura Cod.01 - 03 per rivestimento in pelle.
- Cucitura Cod.03 per rivestimento in tessuto.
- Inserimento letto non possibile.
- Lato componibile non rifinito.

### Caratteristiche optional su richiesta senza maggiorazione

- Piede in legno verniciato nei colori standard Noce (Cod.02), Wengè (Cod.05).
- Disponibile con cucitura a contrasto, per la scelta del colore fare riferimento ai codici del campionario pelli.

### Caratteristiche optional su richiesta con maggiorazione

- Batteria al litio per movimentare il meccanismo in assenza di elettricità. Considerare una batteria per ogni seduta recliner o schienale motorizzato.
- Solo per le versioni dove previsto, il lato componibile può essere rifinito.
- Per il multi rivestimento il prezzo va incrementato del 7%. Per maggiori dettagli fare riferimento al paragrafo "NOTE" posto nelle prime pagine del listino.

### Note

- Le versioni recliner sono consegnate a moduli separati.
- Si consiglia di non comporre fra loro i moduli A - B in quanto le sezioni di divisione della seduta/schienale hanno dimensioni diverse fra i vari gruppi.
- Non è possibile applicare altre cuciture.
- Per alcuni tessuti e velluti l'azienda si riserva di applicare la cucitura Cod.00 / Cod.03 (vedi immagine).

### Standard features

- Frame: wooden structure, seat and back suspensions in reinforced elastic webbing.
- Paddings in eco-friendly open cell polyurethane foam, with different densities.
- Covering in leather or fabric. Not removable coverings.
- Legs in Gunmetal (Cod.50), Antique bronze (Cod.52).
- Stationary versions with electric mechanism for the headrest which allows to increase its height of cm 20.
- Reclining versions with electric mechanism for both seat and headrest.
- All the versions marked by the symbol "↑" are equipped with electric adjustable headrest.
- Stitching type Cod.01 - 03 for leather covering.
- Stitching type Cod.03 for fabric covering.
- No bed version available.
- Sectional sides not finished.

### Optional features available upon request with no upcharge

- Beech wooden leg painted in standard colors Walnut (Cod.02), Wengè (Cod.05).
- Stitching, unless differently requested, will be matching the leather or fabric colour. Contrast stitching colour can be ordered at no extra charge. You might use as reference any Nicoline leather.

### Optional features available upon request with upcharge

- Lithium battery to move the mechanism in the absence of electricity. Please consider one battery per recliner seat or motorized backrest.
- Sectional sides finished (if possible).
- 7% upcharge for combined coverings. Please refer to the notes at the beginning of pricelist.

### Notes

- All reclining versions are made and delivered as separate elements.
- We would suggest choosing versions from the same group and not to combine versions from group A - B, as items from each group have different seat width.
- Different stitchings not available.
- For some fabrics and velvets production dept. must apply the stitching Cod.00 / Cod. 03 (as per picture below).



Piede in metallo // Metal leg



Canna di Fucile (Cod.50) // Gunmetal (Cod.50)



Bronzo Anticato (Cod.52) // Antique Bronze (Cod.52)



Piede in legno // Wooden leg

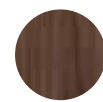

Noce (Cod.02) // Walnut (Cod.02)



Wengè (Cod.05) // Wengè(Cod.05)

Cuciture // Stitching

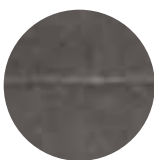

Cod.00

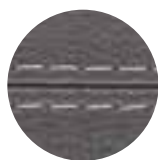

Cod.01

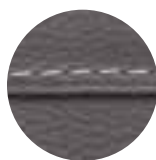

Cod.03

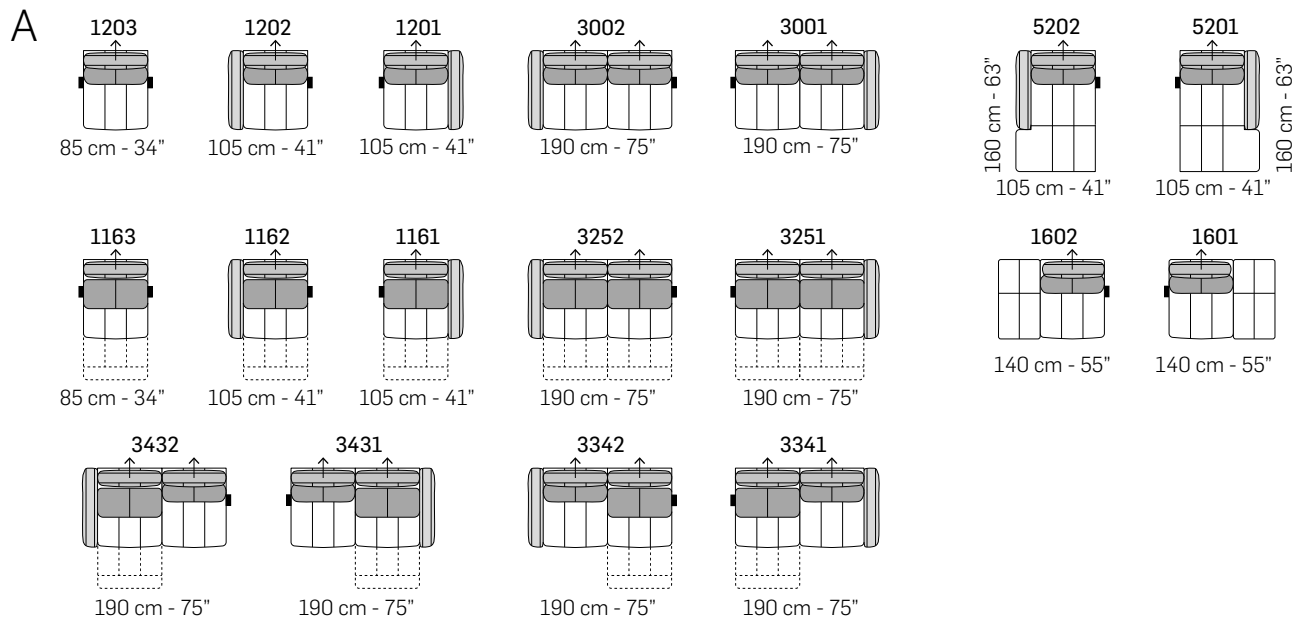
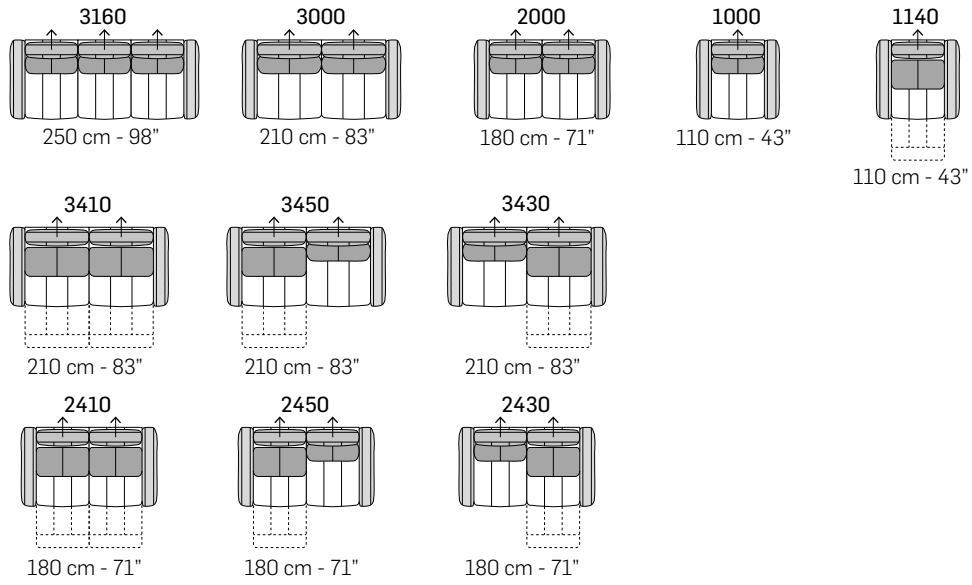

tutti gli elementi del gruppo A hanno lo stesso modulo di seduta - all items in group A have the same seat width

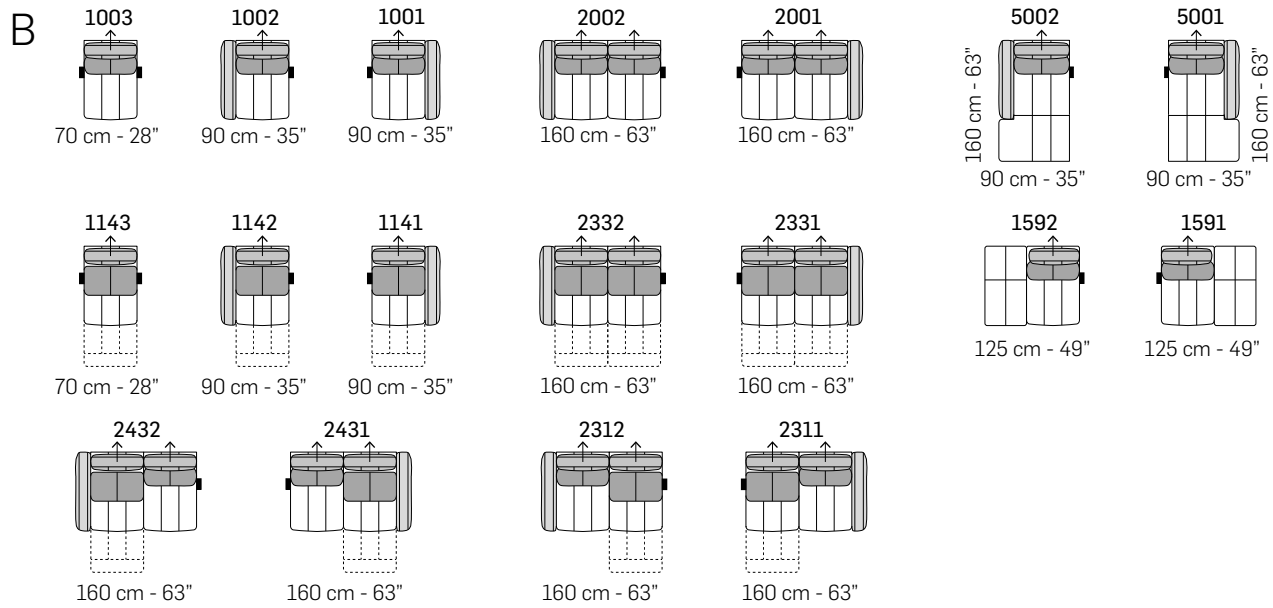

tutti gli elementi del gruppo B hanno lo stesso modulo di seduta - all items in group B have the same seat width

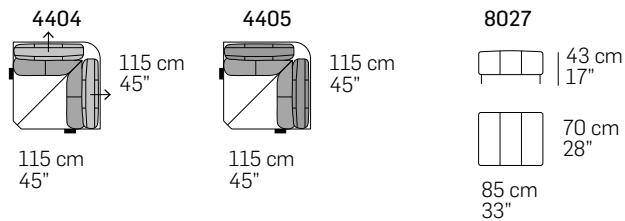

COMPOSIZIONI CONSIGLIATE / SUGGESTED COMPOSITIONS

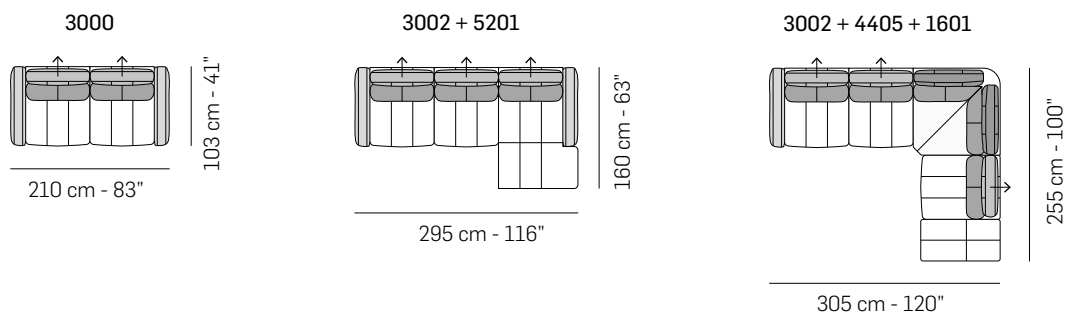

Scala 1:100  
Ratio 1 to 100

Legenda / Legend

- Spalliera / Back Cushions
- Bracciolo / Armrest
- Aggancio Componibile / Connector
- Poggiareni / Kidneyrest
- Seduta / Seat Cushions
- Poggiatesta fisso / Fixed headrest
- ↑ Poggiatesta regolabile / Adjustable headrest

Note / Notes

Nicoline si riserva il diritto di apportare in ogni momento modifiche tecniche ed estetiche / Nicoline reserves the right to change, at any time and without prior warning, technical and aesthetic specifications of the articles.



# ANTARES LIVING

Design Application N° 402020000002749

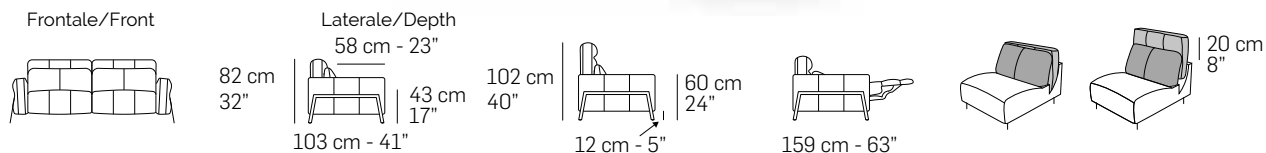

## Caratteristiche standard

- Struttura in legno e multistrato, molleggio seduta e schienale con cinghie elastiche.
- Imbottiture in poliuretano espanso ecologico a cellula aperta con densità differenziate.
- Rivestimento in pelle o tessuto. Tutti i rivestimenti sono fissi.
- Piede in metallo Canna di fucile (Cod.50), Bronzo anticato (Cod.52).
- Versioni fisse con meccanismo poggiatesta elettrico che aumenta l'altezza dello stesso di cm 20.
- Versioni recliner con meccanismo elettrico sia per la seduta che per il poggiatesta.
- Tutte le versioni contrassegnate dal simbolo ^↑, sono dotate di poggiatesta regolabile elettricamente.
- Cucitura Cod.01 - 03 per rivestimento in pelle.
- Cucitura Cod.03 per rivestimento in tessuto.
- Inserimento letto non possibile.
- Lato componibile non rifinito.

## Caratteristiche optional su richiesta senza maggiorazione

- Disponibile con cucitura a contrasto, per la scelta del colore fare riferimento ai codici del campionario pelli.

## Caratteristiche optional su richiesta con maggiorazione

- Batteria al litio per movimentare il meccanismo in assenza di elettricità. Considerare una batteria per ogni seduta recliner o schienale motorizzato.
- Solo per le versioni dove previsto, il lato componibile può essere rifinito.
- Per il multi rivestimento il prezzo va incrementato del 7%. Per maggiori dettagli fare riferimento al paragrafo "NOTE" posto nelle prime pagine del listino.

## Note

- Le versioni recliner sono consegnate a moduli separati.
- Si consiglia di non comporre fra loro i moduli A - B in quanto le sezioni di divisione della seduta/schienale hanno dimensioni diverse fra i vari gruppi.
- Non è possibile applicare altre cuciture.
- Per alcuni tessuti e velluti l'azienda si riserva di applicare la cucitura Cod.00 / Cod.03 (vedi immagine).

## Standard features

- Frame: wooden structure, seat and back suspensions in reinforced elastic webbing.
- Paddings in eco-friendly open cell polyurethane foam, with different densities.
- Covering in leather or fabric. Not removable coverings.
- Legs in Gunmetal (Cod.50), Antique bronze (Cod.52).
- Stationary versions with electric mechanism for the headrest which allows to increase its height of cm. 20.
- Reclining versions with electric mechanism for both seat and headrest.
- All the versions marked by the symbol ^↑ are equipped with electric adjustable headrest.
- Stitching type Cod.01 - 03 for leather covering.
- Stitching type Cod.03 for fabric covering.
- No bed version available.
- Sectional sides not finished.

## Optional features available upon request with no upcharge

- Stitching, unless differently requested, will be matching the leather or fabric colour. Contrast stitching colour can be ordered at no extra charge. You might use as reference any Nicoline leather.

## Optional features available upon request with upcharge

- Lithium battery to move the mechanism in the absence of electricity. Please consider one battery per recliner seat or motorized backrest.
- Sectional sides finished (if possible).
- 7% upcharge for combined coverings. Please refer to the notes at the beginning of pricelist.

## Notes

- All reclining versions are made and delivered as separate elements.
- We would suggest choosing versions from the same group and not to combine versions from group A - B, as items from each group have different seat width.
- Different stitchings not available.
- For some fabrics and velvets production dept. must apply the stitching Cod.00 / Cod. 03 (as per picture below).



Canna di Fucile (Cod.50) //  
Gunmetal (Cod.50)



Bronzo Anticato (Cod.52) //  
Antique Bronze (Cod.52)

Piede in metallo //  
Metal leg

Cuciture //  
Stitching

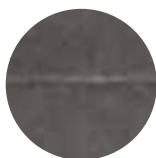

Cod.00

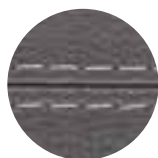

Cod.01

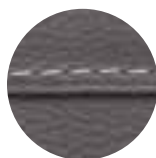

Cod.03

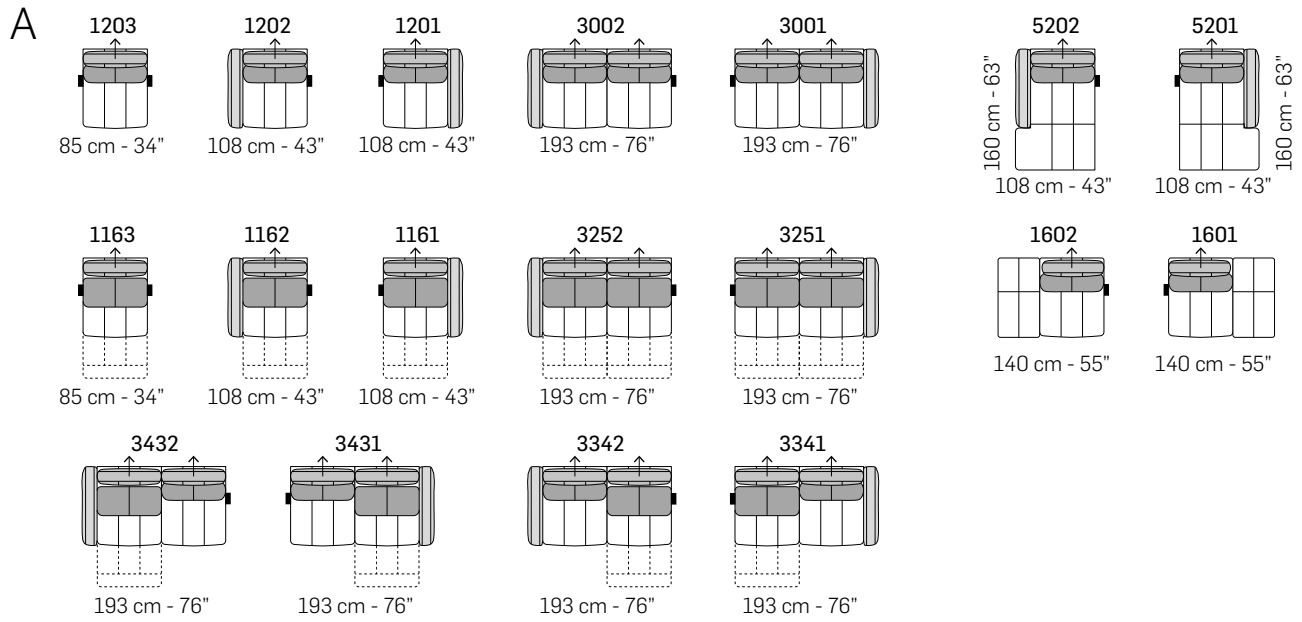
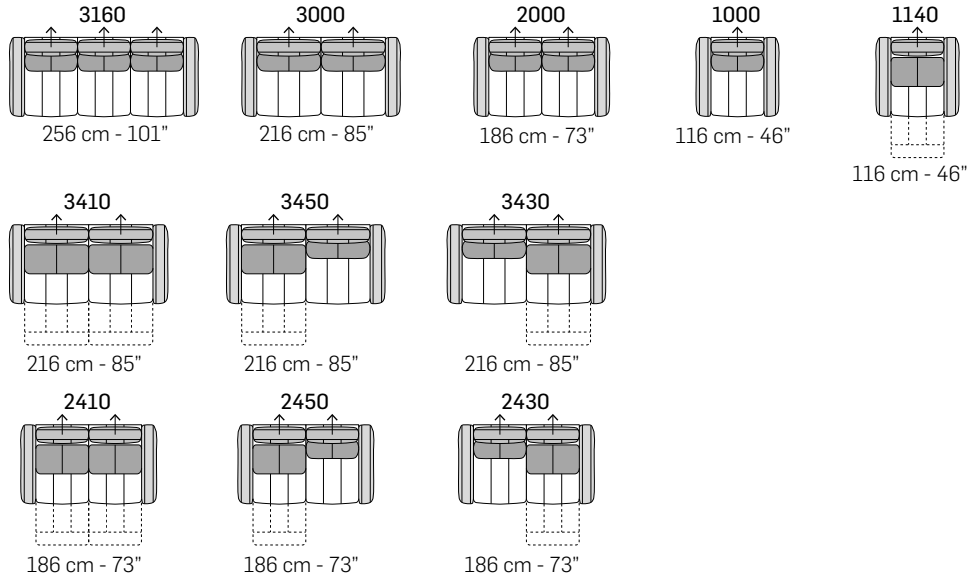

tutti gli elementi del gruppo A hanno lo stesso modulo di seduta - all items in group A have the same seat width

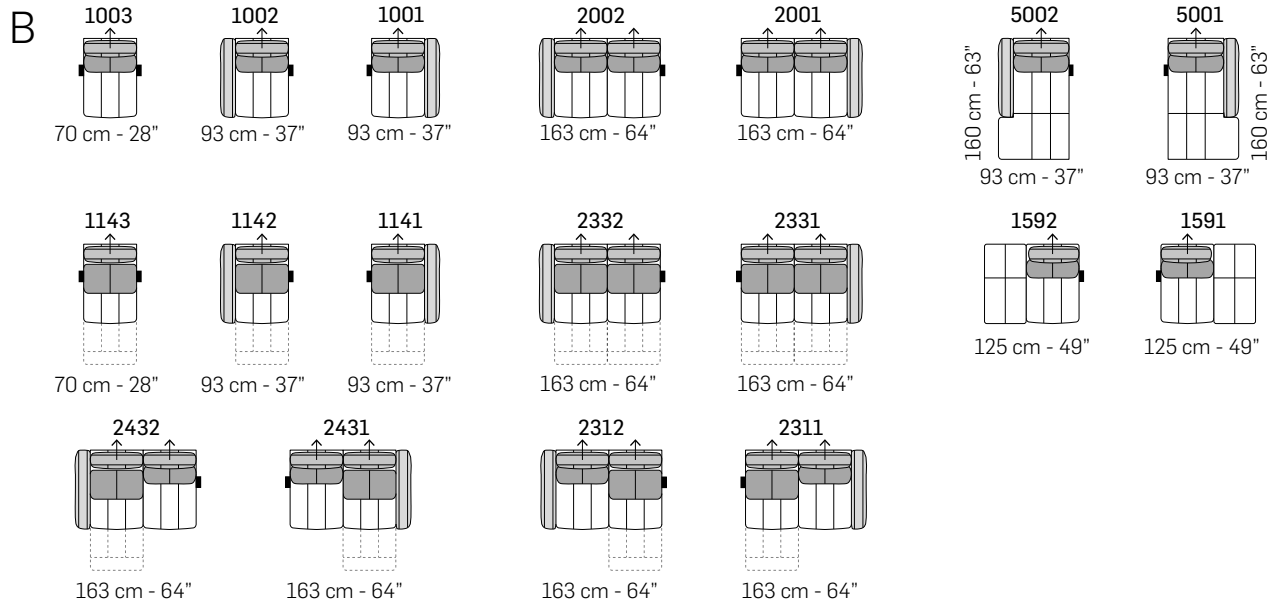

tutti gli elementi del gruppo B hanno lo stesso modulo di seduta - all items in group B have the same seat width

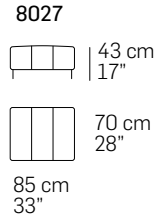
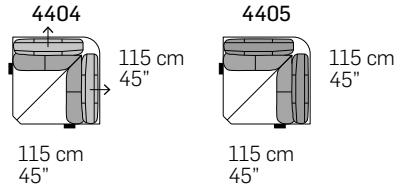

COMPOSIZIONI CONSIGLIATE / SUGGESTED COMPOSITIONS

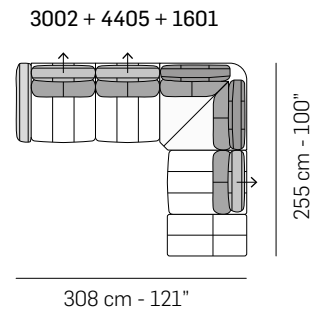
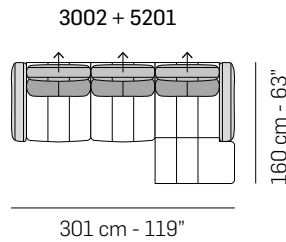
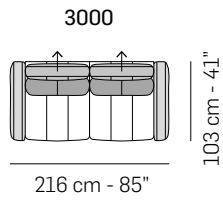

Scala 1:100  
 Ratio 1 to 100

Legenda / Legend

- Spalliera / Back Cushions
- Bracciolo / Armrest
- Aggancio Componibile / Connector
- Poggiareni / Kidneyrest
- Seduta / Seat Cushions
- Poggiatesta fisso / Fixed headrest
- ↑ Poggiatesta regolabile / Adjustable headrest

Note / Notes

Nicoline si riserva il diritto di apportare in ogni momento modifiche tecniche ed estetiche / Nicoline reserves the right to change, at any time and without prior warning, technical and aesthetic specifications of the articles.





# BOLTON

Design Application n° 402020000002749

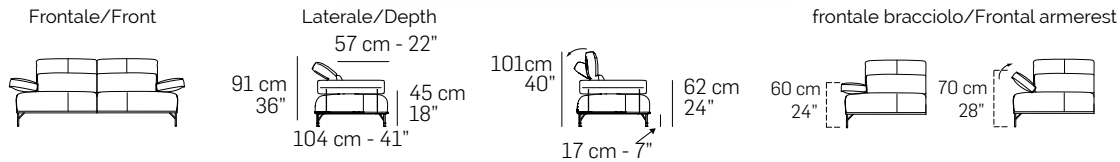

### Caratteristiche standard

- Struttura in legno e multistrato, molleggio seduta e spalliera con cinghie elastiche.
- Imbottiture in poliuretano espanso ecologico a cellula aperta con densità differenziate.
- Rivestimento in pelle o tessuto. Tutti i rivestimenti sono fissi.
- Rivestimento in pelle con seduta trapuntata.
- Braccioli movimentati da meccanismo a posizione variabile.
- Cucitura Cod.01 per rivestimento in pelle, nella seduta e parte centrale del poggiatesta.
- Cucitura Cod.03 per rivestimento in tessuto.
- Inserimento letto non possibile.
- Lato componibile rifinito.

### Caratteristiche optional su richiesta senza maggiorazione

- Disponibile con cucitura a contrasto, per la scelta del colore fare riferimento ai codici del campionario pelli.

### Caratteristiche optional su richiesta con maggiorazione

- Per il multi rivestimento il prezzo va incrementato del 7%. Per maggiori dettagli fare riferimento al paragrafo "NOTE" posto nelle prime pagine del listino.

### Note

- Non è possibile applicare altre cuciture.
- Per alcuni tessuti e velluti l'azienda si riserva di applicare la cucitura Cod.00 / Cod.03 (vedi immagine).

### Standard features

- Frame: wooden structure, seat suspensions in reinforced elastic webbing.
- Paddings in eco-friendly open cell polyurethane foam, with different densities.
- Covering in leather or fabric. Not removable coverings.
- For leather covering, the top of the seat cushion will be quilted.
- For fabric covering, the top of the seat cushion will be made without any seam.
- All the versions marked by the symbol "↑" are equipped with manual adjustable headrest.
- Legs in Gunmetal (Cod.50), Antique bronze (Cod.52).
- Armrests with adjustable position mechanism.
- Stitching type Cod.01 for leather covering, for the seat and central part of headrest.
- Stitching type Cod.03 for fabric covering.
- Folding bed not available.
- Sectional sides are finished.

### Optional features available upon request with no upcharge

- Stitching, unless differently requested, will be matching the leather or fabric colour. Contrast stitching colour can be ordered at no extra charge. You might use as reference any Nicoline leather.

### Optional features available upon request with an upcharge

- 7% upcharge for combined coverings or patterned fabrics. Please refer to the notes at the beginning of pricelist.

### Notes

- Different stitchings not available.
- For some fabrics and velvets production dept. must apply the stitching Cod.00 / Cod.03 (as per picture below).



Piede in metallo // Metal leg



Canna di Fucile (Cod.50) // Gunmetal (Cod.50)



Bronzo Anticato (Cod.52) // Antique Bronze (Cod.52)



Braccioli movimentati da meccanismo a posizione variabile // Armrests with adjustable position mechanism



Rivestimento in pelle // Leather covering



Rivestimento in tessuto // Fabric covering



Spalliere dotate di poggiatesta regolabile manualmente // Backrests equipped with manually adjustable headrest



Cuciture // Stitching

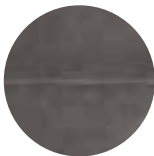

Cod.00

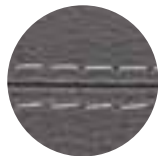

Cod.01

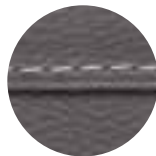

Cod.03

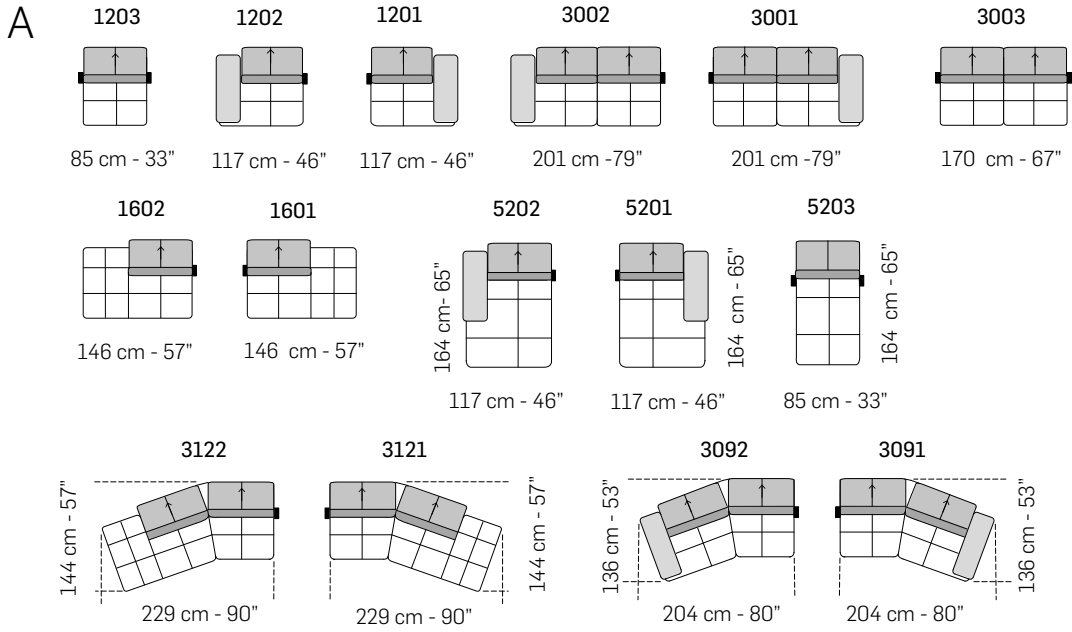
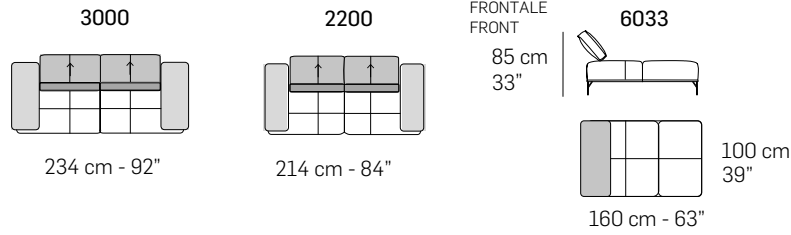

tutti gli elementi del gruppo A hanno lo stesso modulo di seduta - all items in group A have the same seat width

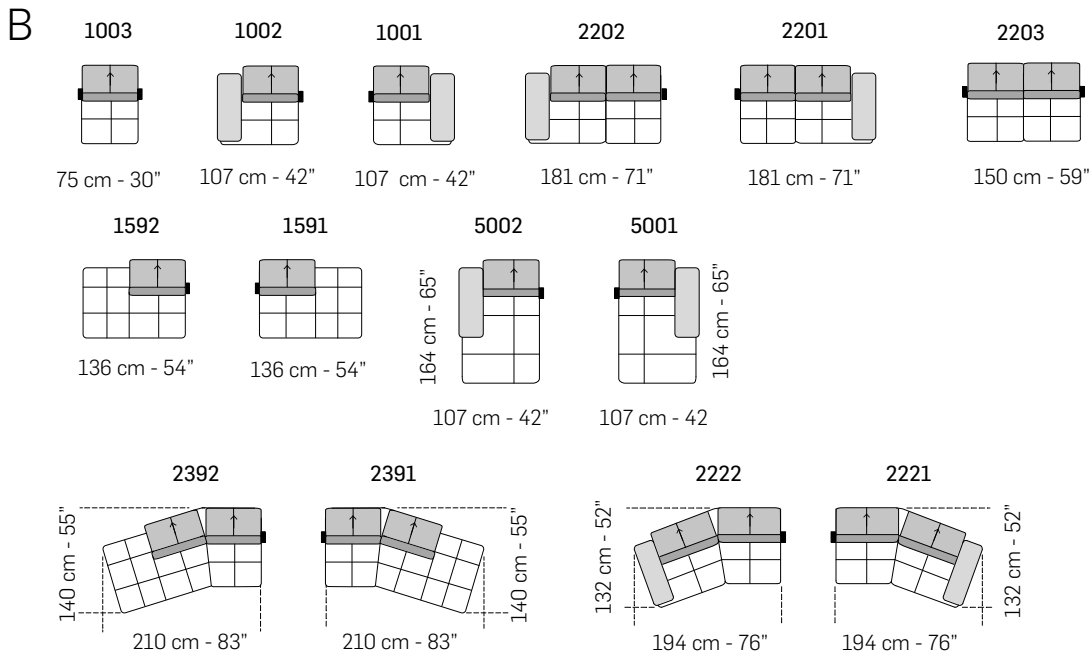

tutti gli elementi del gruppo B hanno lo stesso modulo di seduta - all items in group B have the same seat width

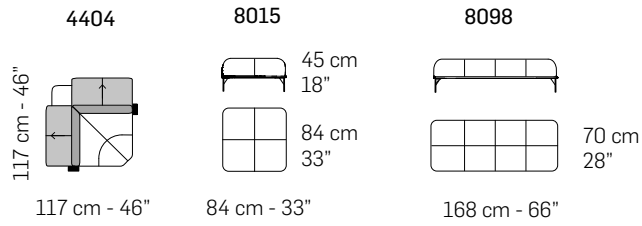

COMPOSIZIONI CONSIGLIATE / SUGGESTED COMPOSITIONS

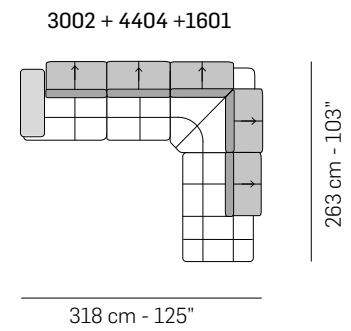
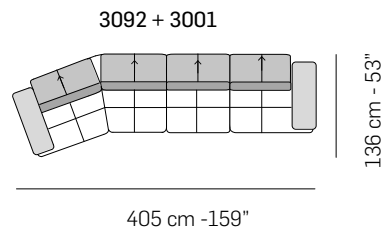
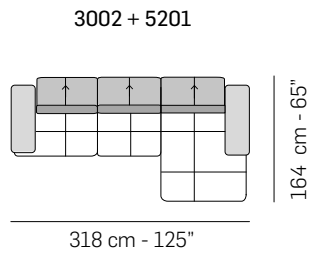

Scala 1:100  
Ratio 1 to 100

Legenda / Legend

- Spalliera / Back Cushions
- Bracciolo / Armrest
- Aggancio Componibile / Connector
- Poggiareni / Kidneyrest
- Seduta / Seat Cushions
- ↑ Poggiatesta regolabile / Adjustable headrest

Note / Notes

Nicoline si riserva il diritto di apportare in ogni momento modifiche tecniche ed estetiche / Nicoline reserves the right to change, at any time and without prior warning, technical and aesthetic specifications of the articles.



# BRESSO

Design Application N° 402017000039849



Frontale/Front

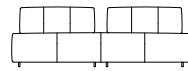

Laterale/Depth  
71 cm - 28"

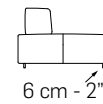
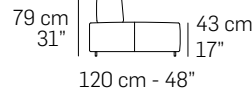

## Caratteristiche standard

- Struttura in legno e multistrato, molleggio seduta con cinghie elastiche.
- Imbottitura in poliuretano espanso ecologico a cellula aperta con densità differenziate, rivestito da un materassino in misto piuma.
- Rivestimento in pelle o tessuto. Tutti i rivestimenti sono fissi.
- Solo per il mercato ITALIA il rivestimento in tessuto è completamente sfoderabile.
- Schienali indipendenti posizionabili liberamente e resi stabili da una struttura interna in metallo.
- Piede in metallo Ral 9005.
- Inserimento letto non possibile.
- Lato componibile rifinito.
- Cucitura Cod.03 per rivestimento in pelle e tessuto.
- Cucitura Cod.06 per parte superiore della seduta con rivestimento in pelle.

## Caratteristiche optional senza maggiorazione

- Nessuna maggiorazione in caso di scelta del solo bordino a contrasto.
- Disponibile con cucitura a contrasto, per la scelta del colore fare riferimento ai codici del campionario pelli.

## Caratteristiche optional con maggiorazione

- Per il multi rivestimento il prezzo va incrementato del 7%. Per maggiori dettagli fare riferimento al paragrafo "NOTE" posto nelle prime pagine del listino.

## Note

- Non è possibile applicare altre cuciture.
- Per alcuni tessuti e velluti l'azienda si riserva di applicare la cucitura Cod.00 / Cod.03 (vedi immagine).

## Standard features

- Frame: wooden structure, seat suspensions in reinforced elastic webbing.
- Padding in eco-friendly open cell polyurethane foam, with different densities, covered with a mixed feather layer.
- Covering in leather or fabric. Not removable coverings.
- Independent, freely movable back cushions, equipped with an internal metal structure.
- Metal legs in Ral 9005.
- No bed version available.
- Sectional sides finished.
- Stitching type Cod.03 for leather and fabric coverings.
- Stitching type Cod.06 for the top part of the seat cushion leather covering.

## Optional features without any upcharge

- No upcharge for contrasting piping.
- Contrast stitching available. Please refer to our leather collection for a thread color indication.

## Optional features with upcharge

- 7% upcharge for combined coverings. Please refer to the notes at the beginning of pricelist.

## Notes

- Different stitchings not available.
- For some fabrics and velvets production dept. must apply the stitching Cod.00 / Cod.03 (as per picture below).



Ral 9005 //  
Ral 9005

Piede in metallo //  
Metal leg

Cuciture//  
Stitching

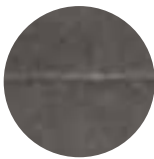

Cod.00

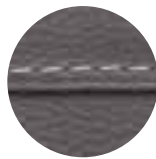

Cod.03

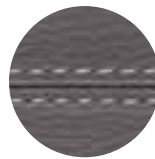

Cod.06

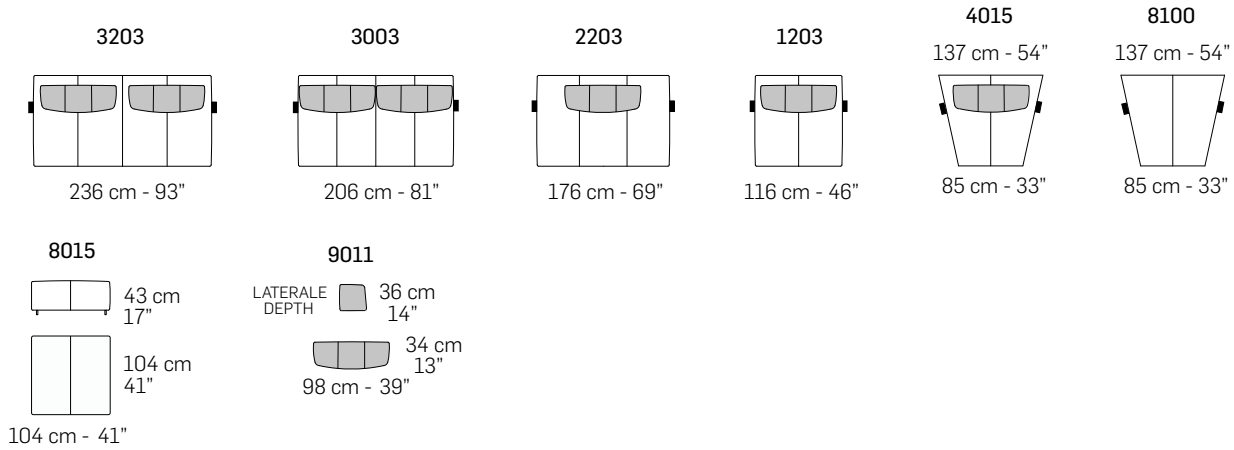

COMPOSIZIONI CONSIGLIATE / SUGGESTED COMPOSITIONS

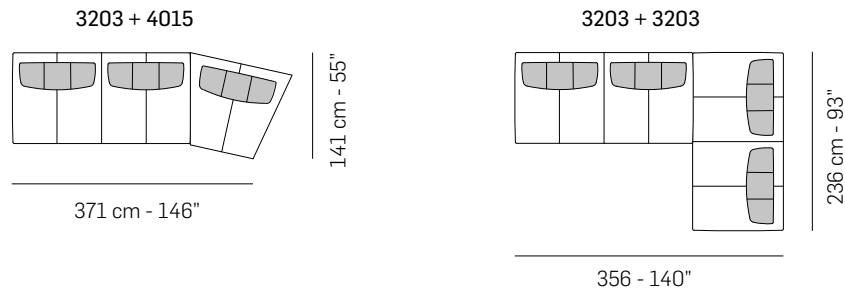

Scala 1:100  
Ratio 1 to 100

Legenda / Legend

■ Spalliera / Back Cushions

□ Seduta / Seat Cushions

■ Aggancio Componibile / Connector

Note / Notes

Nicoline si riserva il diritto di apportare in ogni momento modifiche tecniche ed estetiche / Nicoline reserves the right to change, at any time and without prior warning, technical and aesthetic specifications of the articles.

# CANALETTO

Design Application N°402016000053464



Frontale/Front

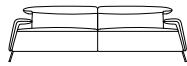

Laterale/Depth

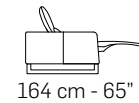
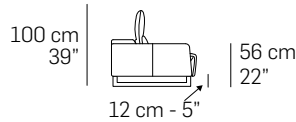
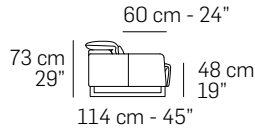

## Caratteristiche standard

- Struttura in legno e multistrato. Molleggio seduta e spalliera con cinghie elastiche.
- Imbottiture in poliuretano espanso ecologico a cellula aperta con densità differenziate.
- Rivestimento in pelle o tessuto. Tutti i rivestimenti sono fissi.
- Versioni recliner con meccanismo elettrico indipendente sia per la seduta sia per il poggiatesta.
- Versioni fisse con meccanismo poggiatesta manuale regolabile.
- Piedi in metallo Lucido (Cod.30), Satinato (Cod.31), Canna di fucile (Cod.50), Bronzo anticato (Cod.52).
- Cucitura Cod.06 per rivestimento in pelle e tessuto.
- Cucitura Cod.11 solo per anteriore / posteriore bracciolo e poggiatesta, per rivestimento in pelle e tessuto.
- Inserimento letto non possibile.
- Lato componibile non rifinito.

## Caratteristiche optional su richiesta senza maggiorazione

- Disponibile con cucitura a contrasto, per la scelta del colore fare riferimento ai codici del campionario pelli.

## Caratteristiche optional su richiesta con maggiorazione

- Batteria al litio per movimentare il meccanismo in assenza di elettricità. Considerare una batteria per ogni seduta recliner.
- Solo per le versioni dove previsto, il lato componibile può essere rifinito.
- Per il multi rivestimento il prezzo va incrementato del 7%. Per maggiori dettagli fare riferimento al paragrafo "NOTE" posto nelle prime pagine del listino.

## Note

- Le versioni recliner sono consegnate a moduli separati.
- Non è possibile applicare altre cuciture.
- Per alcuni tessuti e velluti l'azienda si riserva di applicare la cucitura Cod.00 / Cod.03 (vedi immagine).

## Standard features

- Frame: wooden structure, seat and back suspensions in reinforced elastic webbing.
- Paddings in eco-friendly open cell polyurethane foam with different densities.
- Covering in leather or fabric. Not removable coverings.
- Electrical independent mechanism both on the footrest and headrest for reclining versions.
- Manually adjustable headrest for stationary versions.
- Legs in Shiny metal (Cod.30), Satin (Cod.31), Gunmetal (Cod.50), Antique bronze (Cod.52).
- Stitching type Cod.06 for leather and fabric coverings.
- Stitching type Cod.11 only on the front and back part of armrest and headrest, for all coverings.
- No bed version available.
- Sectional sides not finished.

## Optional features available upon request with no upcharge

- Stitching, unless differently requested, will be matching the leather or fabric colour. Contrast stitching colour can be ordered at no extra charge. You might use as reference any Nicoline leather.

## Optional features available upon request with upcharge

- Lithium battery kit available. One battery pack for each reclining seat.
- Sectional sides finished (if possible).
- 7% upcharge for combined coverings. Please refer to the notes at the beginning of pricelist.

## Notes

- All reclining versions are made and delivered as separate elements.
- Different stitchings not available.
- For some fabrics and velvets production dept. must apply the stitching Cod.00 / Cod.03 (as per picture below).



Piede in metallo // Metal leg

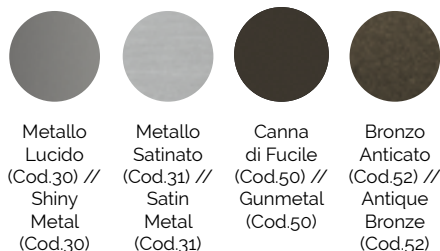

Cuciture//  
Stitching

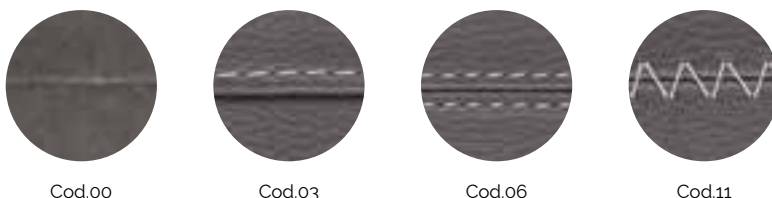



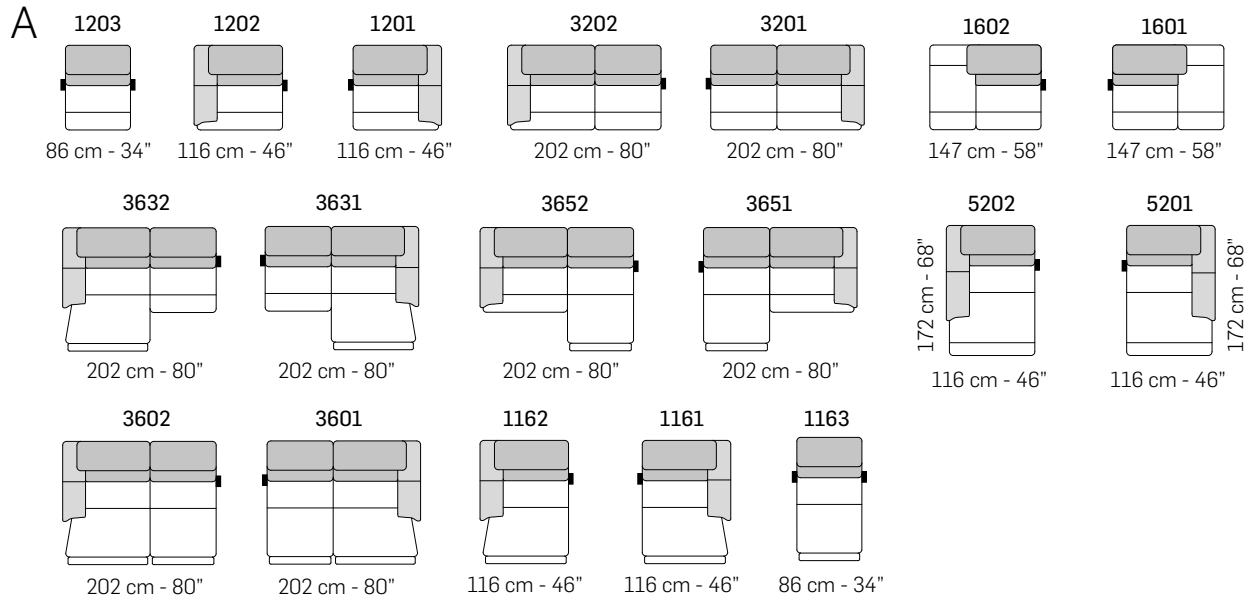
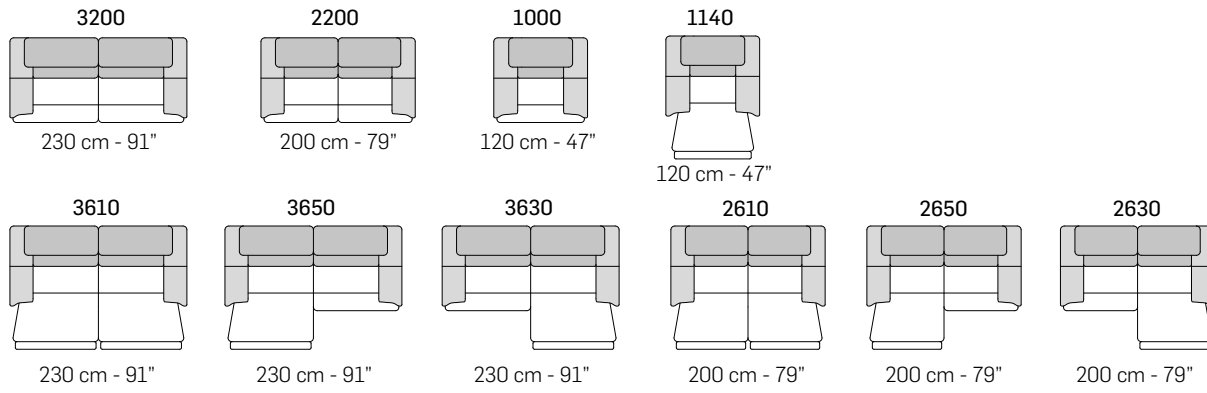

tutti gli elementi del gruppo A hanno lo stesso modulo di seduta - all items in group A have the same seat width

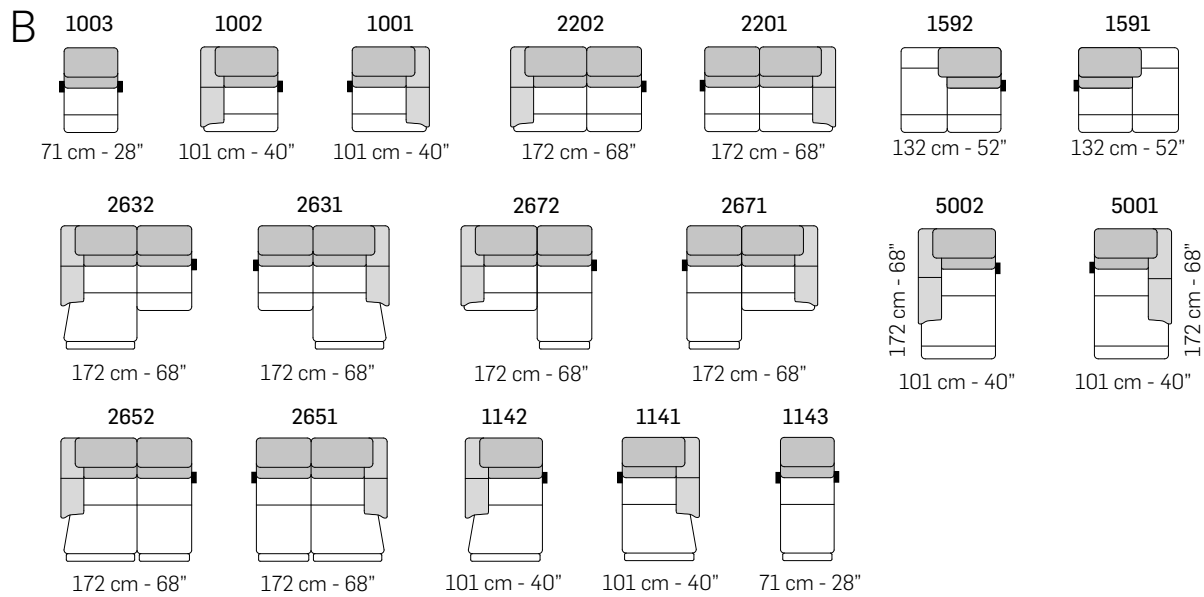

tutti gli elementi del gruppo B hanno lo stesso modulo di seduta - all items in group B have the same seat width

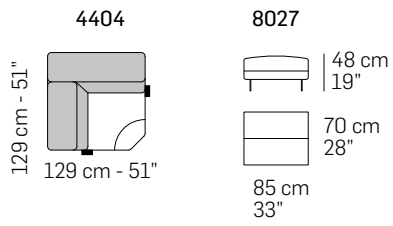

COMPOSIZIONI CONSIGLIATE / SUGGESTED COMPOSITIONS

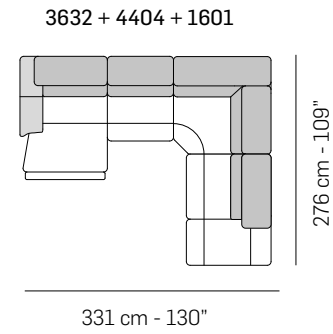
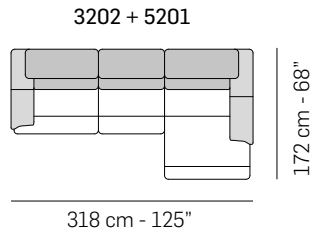
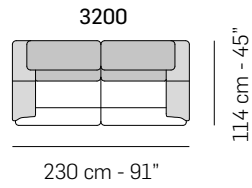

Scala 1:100  
Ratio 1 to 100

Legenda / Legend

- Spalliera / Back Cushions
- Bracciolo / Armrest
- Aggancio Componibile / Connector
- Poggiareni / Kidneyrest
- Seduta / Seat Cushions

Note / Notes

Nicoline si riserva il diritto di apportare in ogni momento modifiche tecniche ed estetiche / Nicoline reserves the right to change, at any time and without prior warning, technical and aesthetic specifications of the articles.



# CAVOUR

Design Application n° 402019000000467

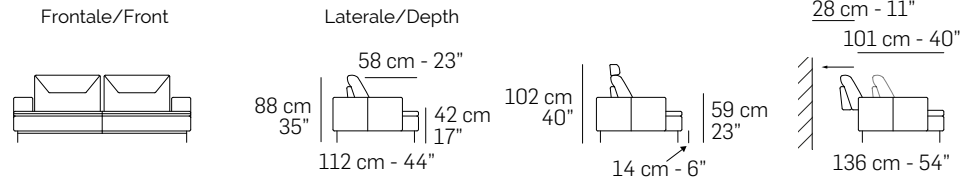

## Caratteristiche standard

- Struttura in legno e multistrato, molleggio seduta con cinghie elastiche.
- Imbottiture in poliuretano espanso ecologico a cellula aperta con densità differenziate.
- Rivestimento in pelle o tessuto. Tutti i rivestimenti sono fissi.
- Piede in metallo Canna di fucile (Cod.50), Bronzo anticato (Cod.52).
- I cuscini di schienale sono dotati di meccanismo "pendular".
- Le cuciture per il rivestimento in pelle sono realizzate nel seguente modo:  
Cucitura Cod.210 parte orizzontale della spalliera e poggiatesta;  
Cucitura Cod.01 fianco spalliera e parte superiore della seduta;  
Cucitura Cod.03 frontale seduta e bracciolo;
- Il rivestimento in tessuto possiede solamente la cucitura Cod.03.
- Inserimento letto non possibile.
- Lato componibile non rifinito.

## Caratteristiche optional su richiesta senza maggiorazione

- Disponibile con cucitura a contrasto, per la scelta del colore fare riferimento ai codici del campionario pelli.

## Caratteristiche optional su richiesta con maggiorazione

- Solo per le versioni dove previsto, il lato componibile può essere rifinito.
- Poggiatesta (Cod.9900) con imbottitura in poliuretano espanso ecologico a cellula aperta e rivestimento sfoderabile.
- Per il multi rivestimento il prezzo va incrementato del 7%. Per maggiori dettagli fare riferimento al paragrafo "NOTE" posto nelle prime pagine del listino.

## Note

- Non è possibile applicare altre cuciture.
- Per alcuni tessuti e velluti l'azienda si riserva di applicare la cucitura Cod.00 / Cod.03 (vedi immagine).

## Standard features

- Frame: wooden structure, seat suspensions in reinforced elastic webbing.
- Paddings in eco-friendly open cell polyurethane foam, with different densities.
- Covering in leather or fabric. Not removable coverings.
- Legs in Gunmetal (Cod.50), Antique bronze (Cod.52).
- Back cushion with pendular mechanism on all elements.
- Stitchings only for the leather covering are being placed as per the following:  
Stitching Cod.210 for the horizontal part of the backrest and for headrest;  
Stitching Cod.01 for the lateral part of the backrest and the top part of the seat;  
Stitching Cod.03 for the frontal part of the seat and for the armrest;
- Stitching cod.03 only for fabric covering.
- No bed version available.
- Sectional sides not finished.

## Optional features available upon request with no upcharge

- Stitching, unless differently requested, will be matching the leather or fabric colour. Contrast stitching colour can be ordered at no extra charge. You might use as reference any Nicoline leather.

## Optional features available upon request with an upcharge

- Sectional sides finished (if possible).
- Headrest (Cod.9900) in eco-friendly open cell polyurethane foam and removable covering.
- 7% upcharge for combined coverings. Please refer to the notes at the beginning of pricelist.

## Notes

- Different stitchings not available.
- For some fabrics and velvets production dept. must apply the stitching Cod.00 / Cod.03 (as per picture below).



Piede in metallo //  
Metal leg



Canna di Fucile (Cod.50) //  
Gunmetal (Cod.50)



Bronzo Anticato (Cod.52) //  
Antique Bronze (Cod.52)



Poggiatesta //  
Headrest

Cuciture //  
Stitching



Cod.00

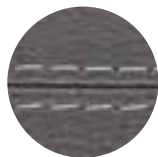

Cod.01

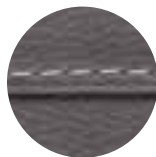

Cod.03

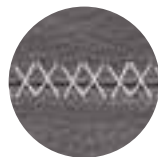

Cod.210

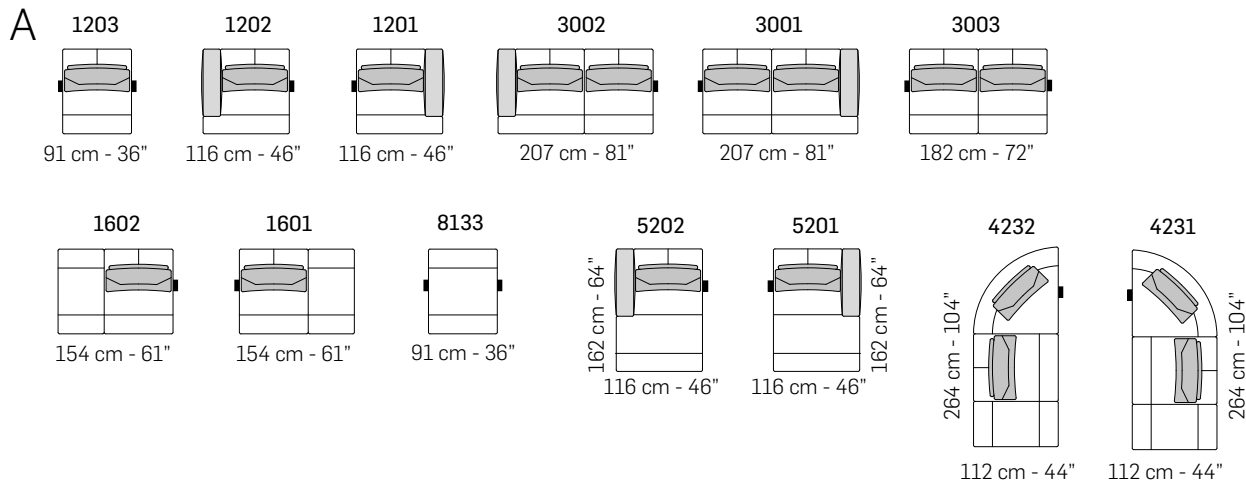
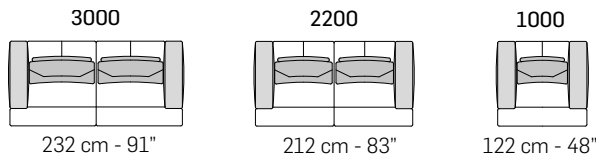

tutti gli elementi del gruppo A hanno lo stesso modulo di seduta - all items in group A have the same seat width

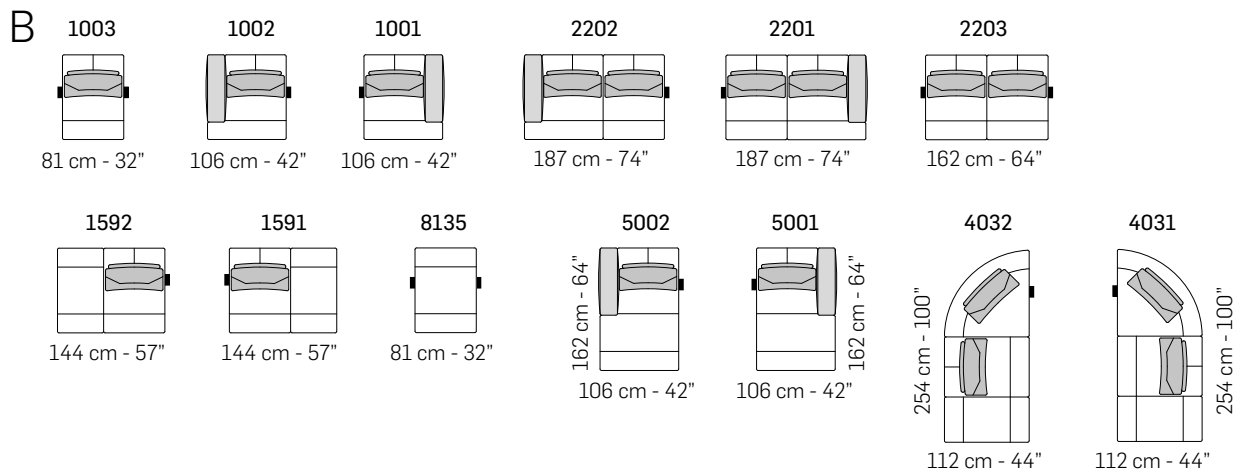

tutti gli elementi del gruppo B hanno lo stesso modulo di seduta - all items in group B have the same seat width

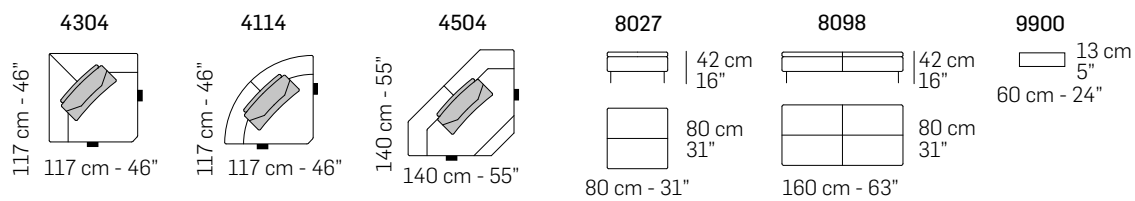

COMPOSIZIONI CONSIGLATE / SUGGESTED COMPOSITIONS

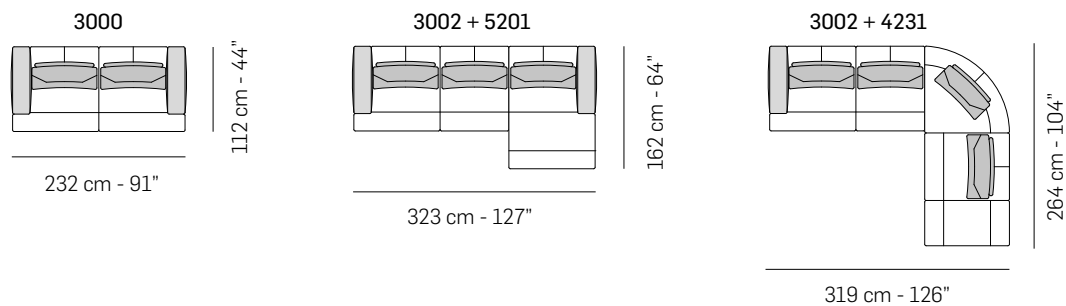

Scala 1:100  
Ratio 1 to 100

Legenda / Legend

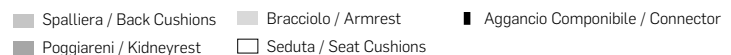

Note / Notes

Nicoline si riserva il diritto di apportare in ogni momento modifiche tecniche ed estetiche / Nicoline reserves the right to change, at any time and without prior warning, technical and aesthetic specifications of the articles.

# CLAIRE

Design Application n° 402020000002749

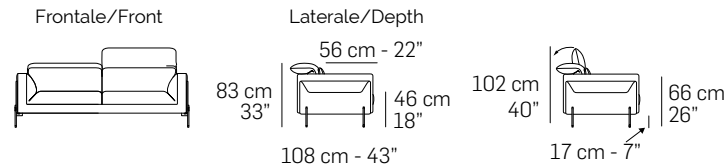

### Caratteristiche standard

- Struttura in legno e multistrato, molleggio seduta e spalliera con cinghie elastiche.
- Imbottiture in poliuretano espanso ecologico a cellula aperta con densità differenziate.
- Rivestimento in pelle o tessuto. Tutti i rivestimenti sono fissi.
- Tutte le versioni contrassegnate dal simbolo '↑', sono dotate di poggiatesta regolabile manualmente.
- Piede in metallo Canna di fucile (Cod.50), Bronzo anticato (Cod.52).
- Elementi Cod.1421- 1422 - 1671 - 1672 - 3031 - 3032 con ripiano in marmo Emperador (Cod.EM) oppure marmo bianco Carrara (Cod.CA).
- Cucitura Cod.06 per rivestimento in pelle, nella parte superiore della seduta. Parti restanti con cucitura Cod.03.
- Cucitura Cod.03 per rivestimento in tessuto.
- Inserimento letto non possibile.
- Lato componibile rifinito.

### Caratteristiche optional su richiesta senza maggiorazione

- Disponibile con cucitura a contrasto, per la scelta del colore fare riferimento ai codici del campionario pelli.

### Caratteristiche optional su richiesta con maggiorazione

- Pannello esterno scocca bracciolo con rivestimento differente rispetto al resto del divano (Config.1).
- Per il multi rivestimento, tranne il pannello bracciolo che ha maggiorazioni dedicate, il prezzo va incrementato del 7%. Per maggiori dettagli fare riferimento al paragrafo "NOTE" posto nelle prime pagine del listino.

### Note

- I disegni grafici che riportano l'asterisco (\*) sono sempre con lato rifinito e anche agganciabili agli elementi componibili.
- Non è possibile applicare altre cuciture.
- Per alcuni tessuti e velluti l'azienda si riserva di applicare la cucitura Cod.00 / Cod.03 (vedi immagine).

### Standard features

- Frame: wooden structure, seat suspensions in reinforced elastic webbing.
- Paddings in eco-friendly open cell polyurethane foam, with different densities.
- Covering in leather or fabric. Not removable coverings.
- All the versions marked by the symbol '↑' are equipped with manual adjustable headrest.
- Legs in Gunmetal (Cod.50), Antique Bronze (Cod.52).
- Versions Cod.1421- 1422 - 1671 - 1672 - 3031 - 3032 with top in marble Emperador (Cod.EM) or White Carrara marble (Cod.CA).
- Stitching type Cod.06 for leather covering for the top of the seat cushion. Stitching type cod.03 for the other parts.
- Stitching type Cod.03 for fabric covering.
- Folding bed not available.
- Sectional sides are finished.

### Optional features available upon request with no upcharge

- Stitching, unless differently requested, will be matching the leather or fabric colour. Contrast stitching colour can be ordered at no extra charge. You might use as reference any Nicoline leather.

### Optional features available upon request with an upcharge

- External panel of the armrest frame with a different covering from the rest of the sofa (Config. 1).
- 7% upcharge for combined coverings (except for the armrest panel which has dedicated upcharge). Please refer to the NOTES at the beginning of pricelist.

### Notes

- Versions with asterisk (\*) have always the terminal side finished with the possibility to be connected to modular elements.
- Different stitchings not available.
- For some fabrics and velvets production dept. must apply the stitching Cod.00 / Cod.03 (as per picture below).



Piede in metallo // Metal leg



Canna di Fucile (Cod.50) // Gunmetal (Cod.50)



Bronzo Anticato (Cod.52) // Antique Bronze (Cod.52)



Elementi // Versions



Marmo Emperador (Cod.EM) // Emperador Marble (Cod.EM)



Marmo Bianco Carrara (Cod.CA) // White Carrara Marble (Cod.CA)

Cuciture // Stitching

Pelle // Leather



Cod.00

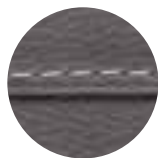

Cod.03

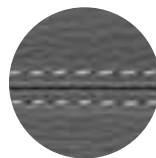

Cod.06



Spalliere dotate di poggiatesta regolabile manualmente // Backrests equipped with manually adjustable headrest



Config. 1

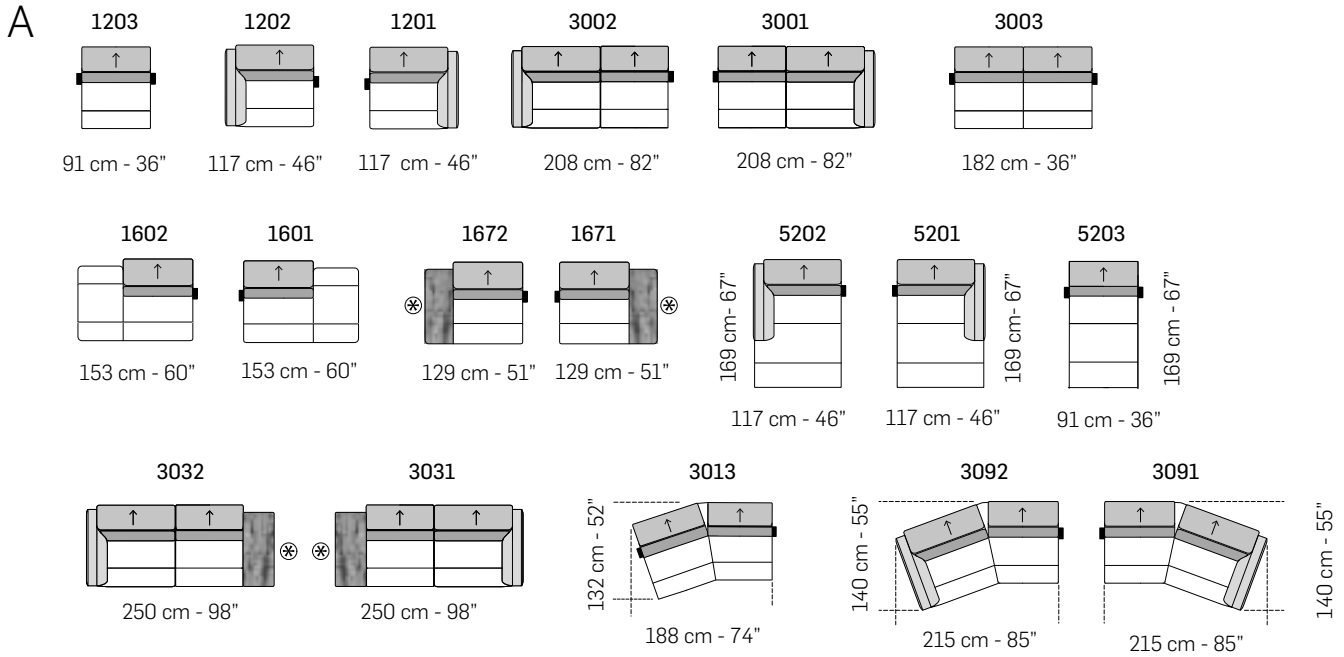
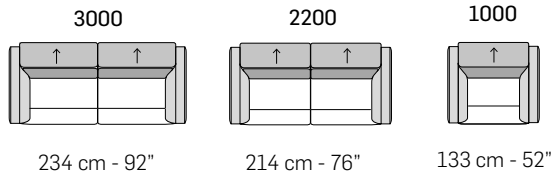

tutti gli elementi del gruppo A hanno lo stesso modulo di seduta - all items in group A have the same seat width

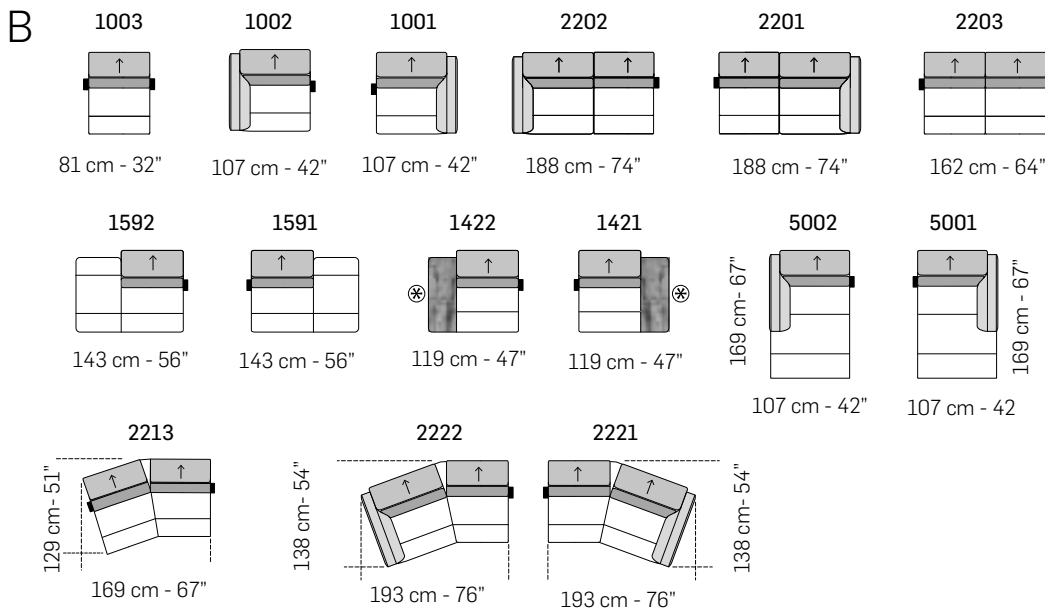

tutti gli elementi del gruppo B hanno lo stesso modulo di seduta - all items in group B have the same seat width

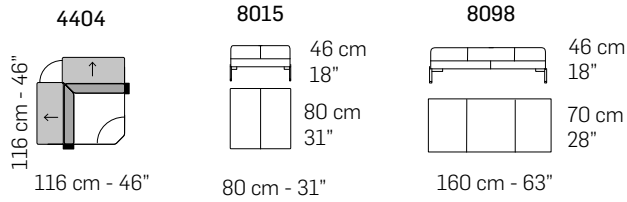

COMPOSIZIONI CONSIGLIATE / SUGGESTED COMPOSITIONS

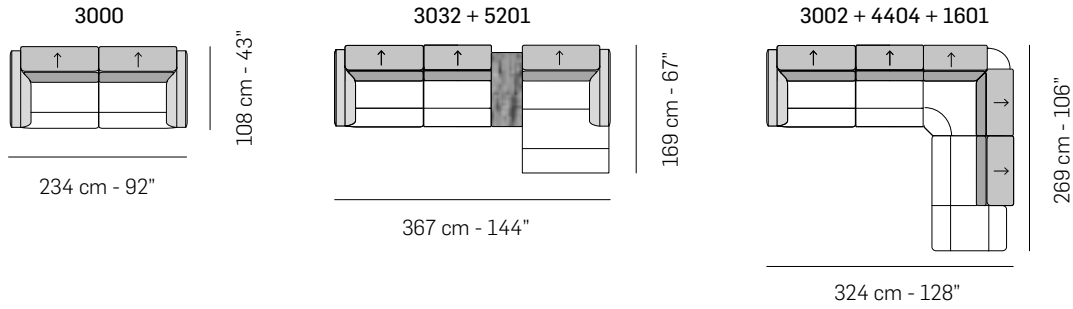

Scala 1:100  
Ratio 1 to 100

Legenda / Legend

- Spalliera / Back Cushions
- Bracciolo / Armrest
- Marmo / Marble
- Poggiareni / Kidneyrest
- Seduta / Seat Cushions
- ↑ Poggiatesta regolabile / Adjustable headrest
- ⊗ Lato terminale sempre rifinito e agganciabile agli elementi componibili / Terminal side is always finished and it can also be connected to modular elements
- Aggancio Componibile / Connector

Note / Notes

Nicoline si riserva il diritto di apportare in ogni momento modifiche tecniche ed estetiche / Nicoline reserves the right to change, at any time and without prior warning, technical and aesthetic specifications of the articles.





# GHISOLFA

Design Application n° 402019000000467



Frontale/Front

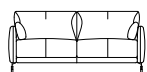

Laterale/Depth

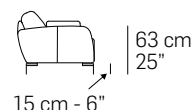

## Caratteristiche standard

- Struttura in legno e multistrato con supporto in metallo, molleggio seduta con cinghie elastiche.
- Cuscini di seduta in poliuretano espanso ecologico a cellula aperta.
- Cuscini di spalliera in misto piuma con inserto in poliuretano espanso ecologico a cellula aperta.
- Cuscini bracciolo in piuma.
- Rivestimento in pelle o tessuto con cuscini di seduta, spalliera e braccioli sfoderabili.
- Solo per il mercato ITALIA il rivestimento in tessuto è completamente sfoderabile.
- Piede in metallo Canna di fucile (Cod.50), Bronzo anticato (Cod.52), entrambe le finiture hanno la parte inferiore verniciata in colore oro satinato.
- Elementi Cod.1421- 1422- 1471- 1472 - 1671 - 1672 - 1731 - 1732 - 8091 - 9506 con ripiano in marmo Emperador (Cod.EM) oppure marmo bianco Carrara (Cod.CA).
- Cucitura Cod.03 per rivestimento in pelle e tessuto.
- Per il rivestimento in pelle, alcuni dettagli sono realizzati con cucitura Cod.01.
- Cerniera bracciolo finitura Canna di fucile (Cod.CF).
- Inserimento letto non possibile.
- Lato componibile rifinito.

## Caratteristiche optional senza maggiorazione

- Disponibile con cucitura a contrasto, per la scelta del colore fare riferimento ai codici del campionario pelli.
- La cerniera presente sul bracciolo può essere eliminata.

## Caratteristiche optional con maggiorazione

- Poggiatesta (Cod.9900) con imbottitura in poliuretano espanso e supporto in metallo rivestito.
- Per il multi rivestimento il prezzo va incrementato del 7%. Per maggiori dettagli fare riferimento al paragrafo "NOTE" posto nelle prime pagine del listino.

## Note

- I disegni grafici che riportano l'asterisco (\*) sono sempre con lato rifinito e anche agganciabili agli elementi componibili.
- Non è possibile applicare altre cuciture.
- Per alcuni tessuti e velluti l'azienda si riserva di applicare la cucitura Cod.00 / Cod.03 (vedi immagine).

## Standard features

- Frame: wooden structure with metal support, seat suspensions in reinforced elastic webbing.
- Seat cushions in eco-friendly open cell polyurethane foam.
- Back cushions in mixed feather with the insert in eco-friendly open cell polyurethane foam.
- Armrest cushions in feather.
- Covering in leather or fabric. Seat, back and armrest cushions coverings removable.
- Legs in Gunmetal (Cod.50), Antique Bronze (Cod.52), both finishes with lower part painted in matte gold color.
- Versions Cod. 1421- 1422- 1471- 1472 - 1671 - 1672 - 1731 - 1732 - 8091 - 9506 with top in marble Emperador (Cod.EM) or White Carrara marble (Cod.CA).
- Stitching type Cod.03 for leather and fabric coverings.
- Stitching type Cod.01 for some details only for leather covering.
- Armrest zip in Gunmetal (Cod.CF).
- No bed version available.
- Finished sectional sides.

## Optional features available upon request with no upcharge

- Stitching, unless differently requested, will be matching the leather or fabric colour. Contrast stitching colour can be ordered at no extra charge. You might use as reference any Nicoline leather.
- The zipper present on the armrest can be eliminated.

## Optional features available upon request with an upcharge

- Headrest (Cod.9900) with padding in eco-friendly open cell polyurethane foam and covered metal support.
- 7% upcharge for combined coverings. Please refer to the notes at the beginning of pricelist.

## Notes

- Versions with asterisk (\*) have always the terminal side finished with the possibility to be connected to modular elements.
- Different stitchings not available.
- For some fabrics and velvets production dept. must apply the stitching Cod.00 / Cod.03 (as per picture below).



Canna di Fucile (Cod.50) / Oro Satinato //  
Gunmetal (Cod.50) / Matte Gold color



Bronzo Anticato (Cod.52) / Oro Satinato //  
Antique Bronze (Cod.52) / Matte Gold color

Piede in metallo //  
Metal leg



Marmo Emperador (Cod.EM) //  
Emperador Marble (Cod.EM)



Marmo Bianco Carrara (Cod.CA) //  
White Carrara Marble (Cod.CA)

Elementi //  
Versions

Cuciture //  
Stitching



Cod.00

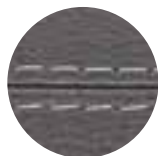

Cod.01

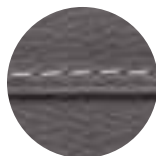

Cod.03



Cerniera bracciolo //  
Armrest zip

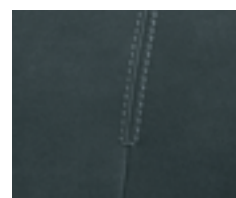

Dettaglio cucitura Cod.01  
per Ghisolfa // Stitching  
Cod.01 for Ghisolfa



Poggiatesta //  
Headrest

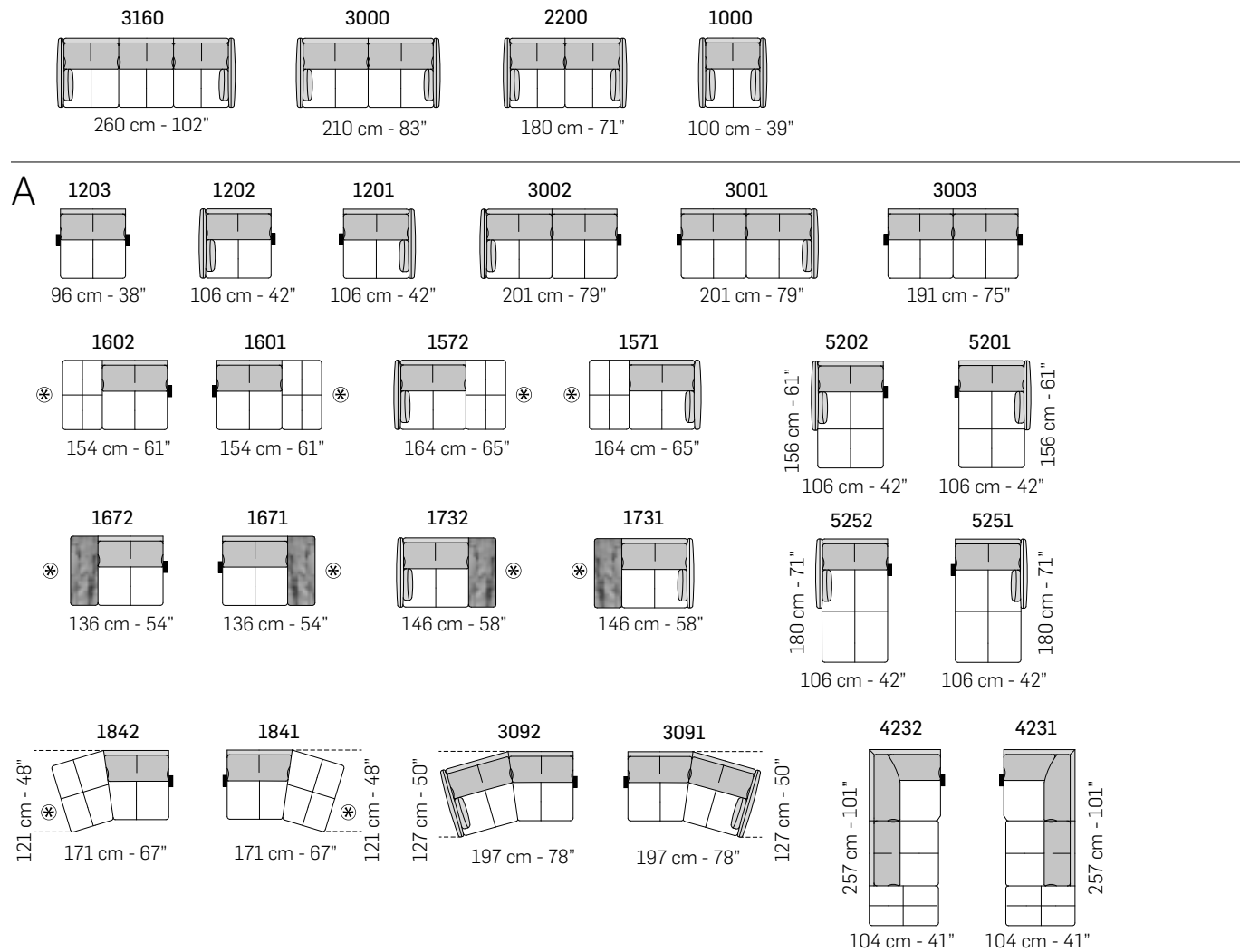

tutti gli elementi del gruppo A hanno lo stesso modulo di seduta - all items in group A have the same seat width

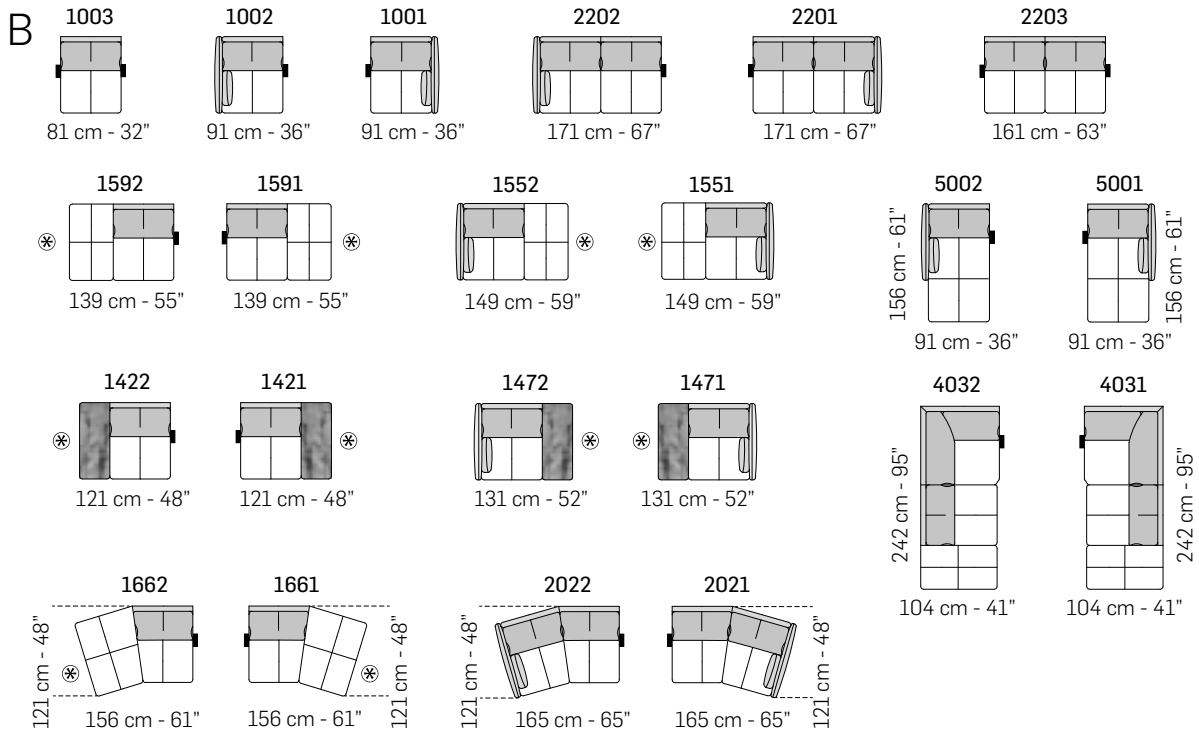

tutti gli elementi del gruppo B hanno lo stesso modulo di seduta - all items in group B have the same seat width

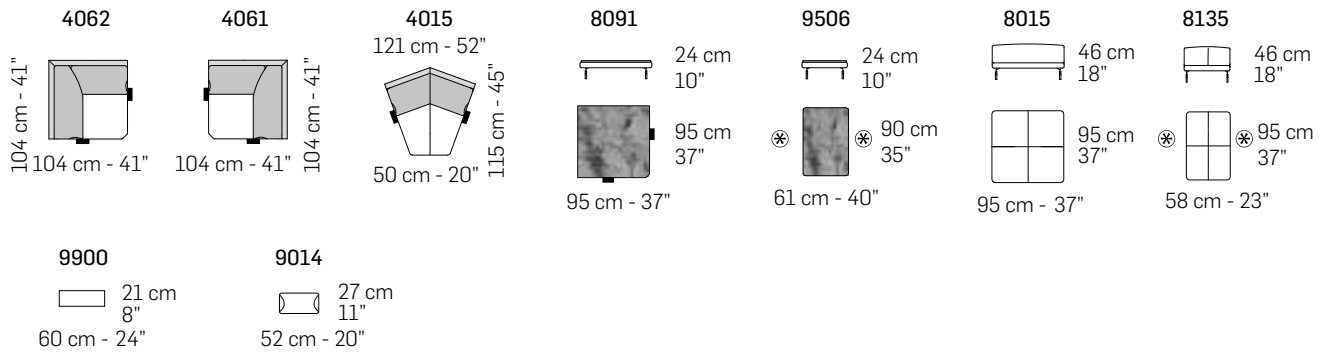

COMPOSIZIONI CONSIGLIATE / SUGGESTED COMPOSITIONS

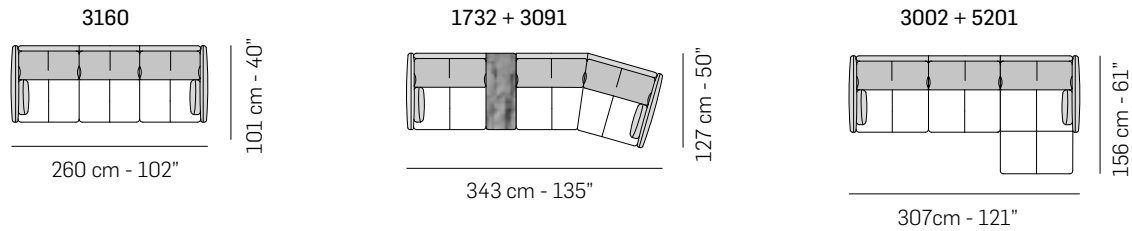

Scala 1:100  
Ratio 1 to 100

Legenda / Legend

- Spalliera / Back Cushions
- Bracciolo / Armrest
- Marmo / Marble
- Poggiareni / Kidneyrest
- Seduta / Seat Cushions
- ⊗ Lato terminale sempre rifinito e agganciabile agli elementi componibili / Terminal side is always finished and it can also be connected to modular elements
- Aggancio Componibile / Connector

Note / Notes

Nicoline si riserva il diritto di apportare in ogni momento modifiche tecniche ed estetiche / Nicoline reserves the right to change, at any time and without prior warning, technical and aesthetic specifications of the articles.



# MANZONI BIG

Design Application n° 402019000001898

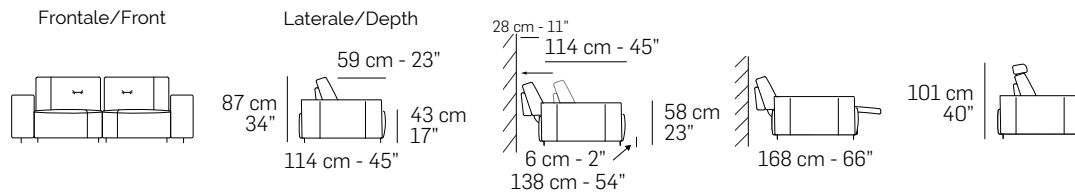

### Caratteristiche standard

- Struttura in legno e multistrato, molleggio seduta con cinghie elastiche.
- Imbottiture in poliuretano espanso ecologico a cellula aperta con densità differenziate.
- Rivestimento in pelle o tessuto. Tutti i rivestimenti sono fissi.
- Bordino "Gros grain" disponibile nei colori Cod.37 - 136 - 164 - 63 - 91 - 101 - 45 - 139 - 116 - 41.
- Piede in metallo Ral 9005.
- Lo schienale possiede un bottone in metallo con finitura Canna di fucile (Cod.CF).
- I cuscini di schienale sono dotati di meccanismo "pendular".
- Versioni recliner con meccanismo elettrico che permette il sollevamento della sola pediera.
- Le cuciture per il rivestimento in pelle sono realizzate nel seguente modo:
  - Cucitura Cod.01 per parte superiore seduta e frontale spalliera;
  - Cucitura Cod.03 per posteriore spalliera;
- Il rivestimento in tessuto non possiede cuciture.
- Inserimento letto non possibile.
- Lato componibile non rifinito.

### Caratteristiche optional su richiesta senza maggiorazione

- Disponibile con cucitura a contrasto. Per la scelta del colore fare riferimento ai codici del campionario pelli.

### Caratteristiche optional con maggiorazione

- Poggiatesta (Cod.9900) con imbottitura in poliuretano espanso ecologico a cellula aperta e rivestimento sfoderabile.
- Batteria al litio per movimentare il meccanismo in assenza di elettricità. Considerare una batteria per ogni seduta recliner.
- Solo per le versioni dove previsto, il lato componibile può essere rifinito.
- Per il multi rivestimento il prezzo va incrementato del 7%. Per maggiori dettagli fare riferimento al paragrafo "NOTE" posto nelle prime pagine del listino.

### Note

- Le versioni contrassegnate con il simbolo "X" devono essere agganciate solamente con la versione Cod.8135 interposta fra due elementi con seduta a martello.
- I disegni grafici che riportano l'asterisco (\*) sono sempre con lato rifinito e anche agganciabili agli elementi componibili.
- Non è possibile applicare altre cuciture.

### Standard features

- Frame: wooden structure, seat suspensions in reinforced elastic webbing.
- Paddings in eco-friendly open cell polyurethane foam with different densities.
- Covering in leather or fabric. Not removable coverings.
- Piping "Gros grain" available in colors Cod.37 - 136 - 164 - 63 - 91 - 101 - 45 - 139 - 116 - 41.
- Legs in Ral 9005.
- The backrest and the padded armrest have a metal button in Gunmetal (Cod.CF).
- Back cushion with pendular mechanism on all elements.
- Recliner versions with an electrical mechanism that moves only the footrest.
- Stitchings only for the leather covering are being placed as per the following:
  - Stitching Cod.01 for the top of the seat and frontal part of backrest;
  - Stitching Cod.03 for the back of the backrest.
- No stitchings for the fabric covering.
- No bed version available.
- Sectional sides not finished.

### Optional features available upon request with no upcharge

- Stitching, unless differently requested, will be matching the leather or fabric colour. Contrast stitching colour can be ordered at no extra charge. You might use as reference any Nicoline leather.

### Optional features available upon request with an upcharge

- Headrest (Cod.9900) in eco-friendly open cell polyurethane foam and removable covering.
- Lithium battery kit available. One battery pack for each reclining seat.
- Sectional sides finished (if possible).
- 7% upcharge for combined coverings. Please refer to the notes at the beginning of pricelist.

### Notes

- Versions marked with the "X" symbol can be hooked only to version Cod.8135 that is positioned between two elements with a hammer seat.
- Versions marked with (\*) asterisk have always the terminal side finished with the possibility to be connected to modular elements.
- Different stitchings not available.



Piede in metallo // Metal leg



Ral 9005 // Ral 9005



La versione Cod.8135 deve essere interposta solo tra due elementi con seduta a martello // The version Cod. 8135 can be located only between two elements with hammer seat

Cuciture // Stitching

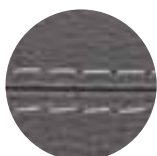

Cod.01

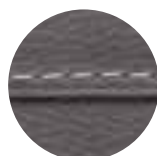

Cod.03



Bracciolo Manzoni Big // Manzoni Big armrest



Schienali dotati di meccanismo "pendular" // Backrests equipped with pendular mechanism



Versioni recliner con meccanismo elettrico // Recliner versions with electric mechanism



Poggiatesta // Headrest



Bordino "Gros Grain" disponibile nei colori | Gros Grain piping available in the following colors |

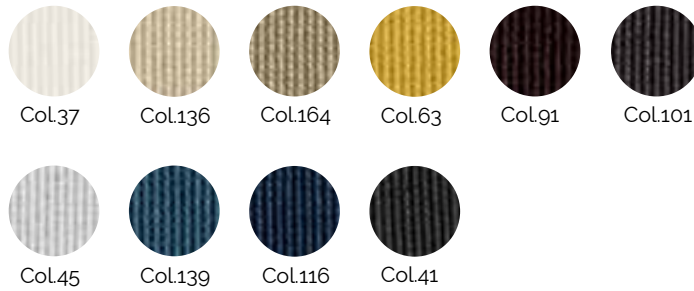

A

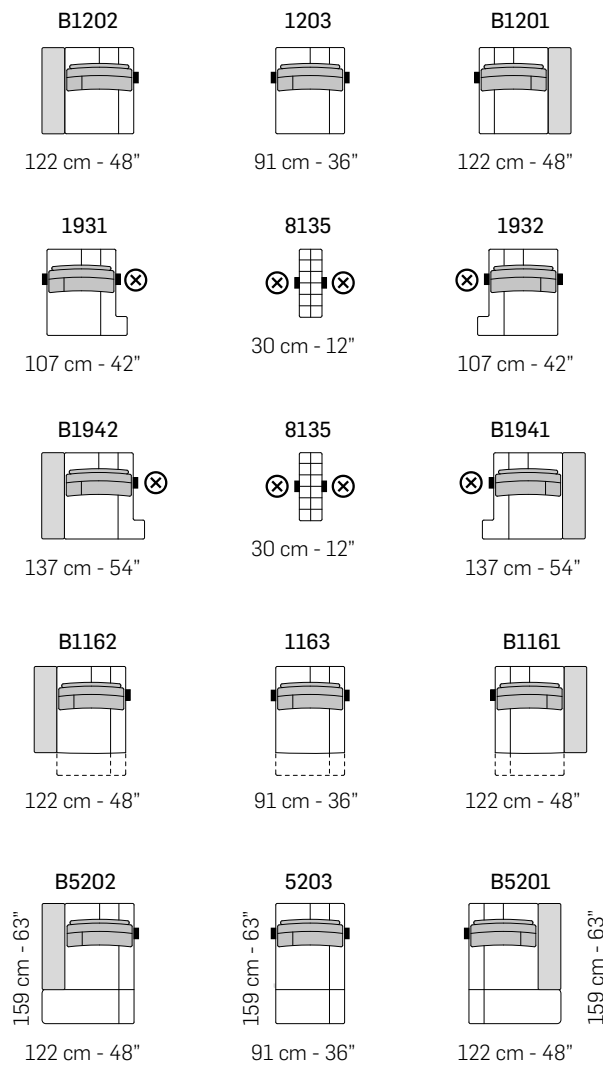

tutti gli elementi del gruppo A hanno lo stesso modulo di seduta - all items in group A have the same seat width

B

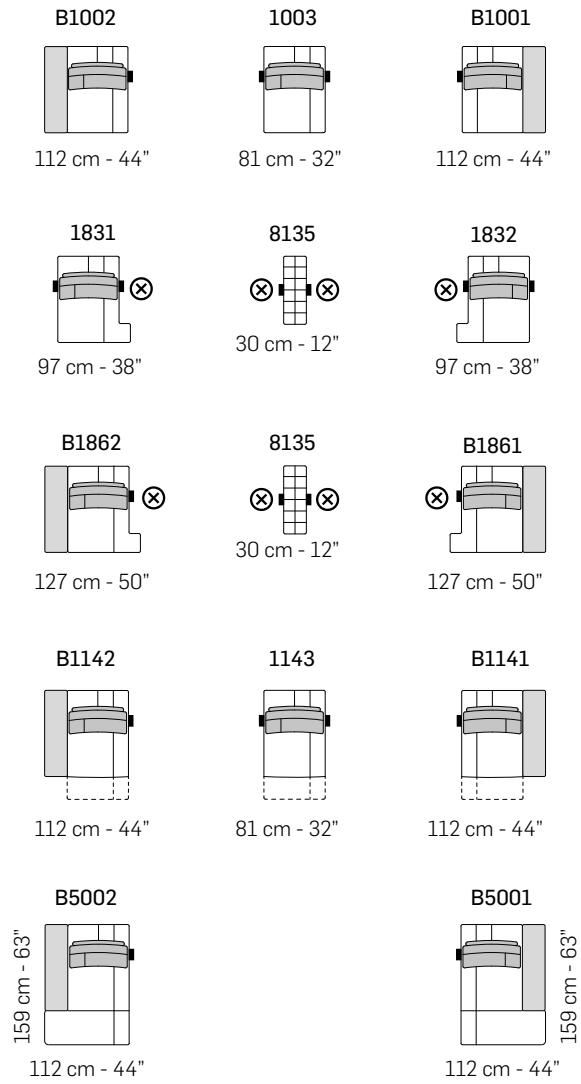

tutti gli elementi del gruppo B hanno lo stesso modulo di seduta - all items in group B have the same seat width

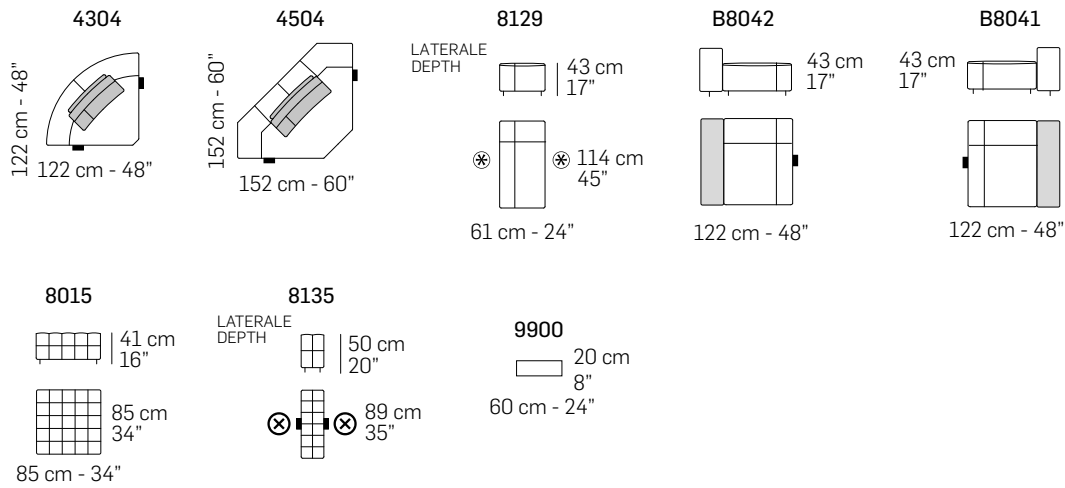



COMPOSIZIONI CONSIGLIATE / SUGGESTED COMPOSITIONS

B1202 + 1203 + B5201

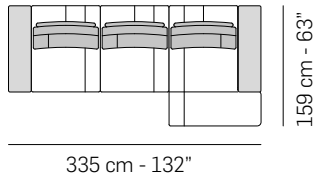

B1202 + 1203 + 4504 + 1203 + 8129

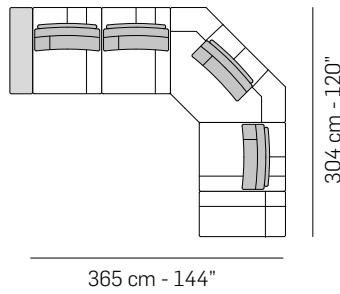

B8042 + 1203 + 4304 + 1203 + B1201

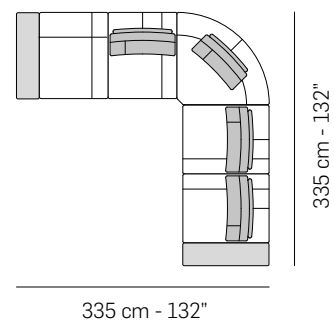

Scala 1:100  
Ratio 1 to 100

Legenda / Legend

- |   |                          |   |
|---|--------------------------|---|
| ■ Spalliera / Back Cushions   | ■ Bracciolo / Armrest    | ■ Aggancio Componibile / Connector  |
| ■ Poggiareni / Kidneyrest   | □ Seduta / Seat Cushions | ⊗ Lato agganciabile obbligatoriamente con la versione 8135/ Side that can only be connected with version 8135 |
| ⊗ Lato terminale sempre rifinito e agganciabile agli elementi componibili / Terminal side is always finished and it can also be connected to modular elements |                          |   |

Note / Notes

Nicoline si riserva il diritto di apportare in ogni momento modifiche tecniche ed estetiche / Nicoline reserves the right to change, at any time and without prior warning, technical and aesthetic specifications of the articles.

# MONFORTE

Design Application N° 402017000135505



Frontale/Front



Laterale/Depth

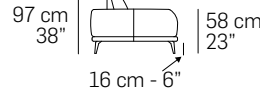
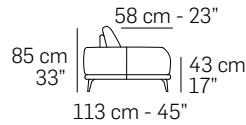

24 cm - 9"

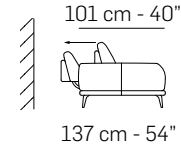

### Caratteristiche standard

- Struttura in legno e multistrato, molleggio seduta con cinghie elastiche.
- Imbottiture in poliuretano espanso ecologico a cellula aperta con densità differenziate.
- Rivestimento in pelle o tessuto. Tutti i rivestimenti sono fissi.
- Piede in metallo Lucido (Cod.30), Satinato (Cod.31), Canna di fucile (Cod.50), Bronzo anticato (Cod.52).
- I cuscini di schienale sono dotati di meccanismo "pendular".
- Cucitura Cod.03 per rivestimento in tessuto.
- Cucitura Cod.07 per rivestimento in pelle.
- Inserimento letto non possibile.
- Lato componibile non rifinito.

### Caratteristiche optional su richiesta senza maggiorazione

- Disponibile con cucitura a contrasto, per la scelta del colore fare riferimento ai codici del campionario pelli.

### Caratteristiche optional su richiesta con maggiorazione

- Solo per le versioni dove previsto, il lato componibile può essere rifinito.
- Poggiatesta (Cod.9900) con imbottitura in poliuretano espanso ecologico a cellula aperta e rivestimento sfoderabile.
- Per il multi rivestimento il prezzo va incrementato del 7%. Per maggiori dettagli fare riferimento al paragrafo "NOTE" posto nelle prime pagine del listino.

### Note

- Non è possibile applicare altre cuciture.
- Per alcuni tessuti e velluti l'azienda si riserva di applicare la cucitura Cod.00 / Cod.03 (vedi immagine).

### Standard features

- Frame: wooden structure, seat suspensions in reinforced elastic webbing.
- Paddings in eco-friendly open cell polyurethane foam with different densities.
- Covering in leather or fabric. Not removable coverings.
- Legs in Shiny metal (Cod.30), Satin metal (Cod.31), Gunmetal (Cod.50), Antique bronze (Cod.52).
- Back cushion with pendular mechanism on all elements.
- Stitching type Cod.03 for fabric coverings.
- Stitching type Cod.07 for leather coverings.
- No bed version available.
- Sectional sides not finished.

### Optional features without any upcharge

- Stitching, unless differently requested, will be matching the leather or fabric colour.
- Contrast stitching available. Please refer to our leather collection for a thread color indication.

### Optional features with upcharge

- Sectional sides finished (if possible).
- Headrest (Cod.9900) in eco-friendly open cell polyurethane foam and removable covering.
- 7% upcharge for combined coverings. Please refer to the notes at the beginning of pricelist.

### Notes

- Different stitchings not available.
- For some fabrics and velvets production dept. must apply the stitching Cod.00 / Cod.03 (as per picture below).



Piede in metallo // Metal leg

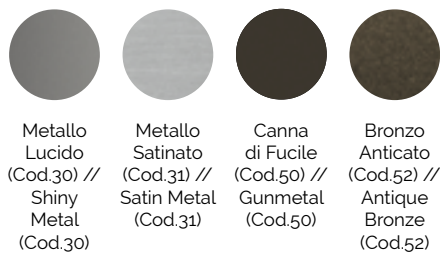

Cuciture // Stitching



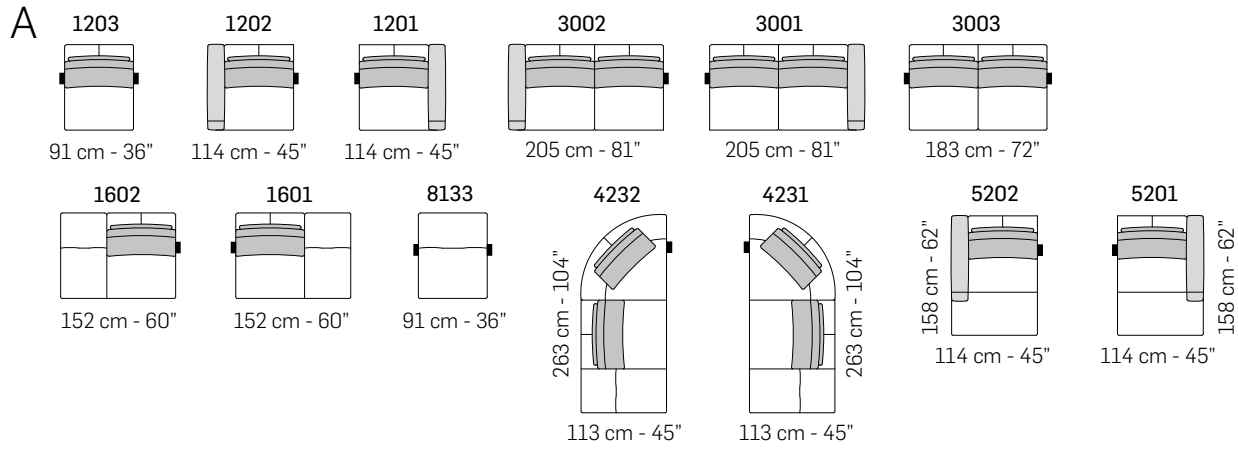
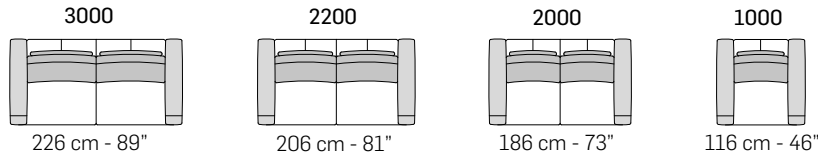

tutti gli elementi del gruppo A hanno lo stesso modulo di seduta - all items in group A have the same seat width

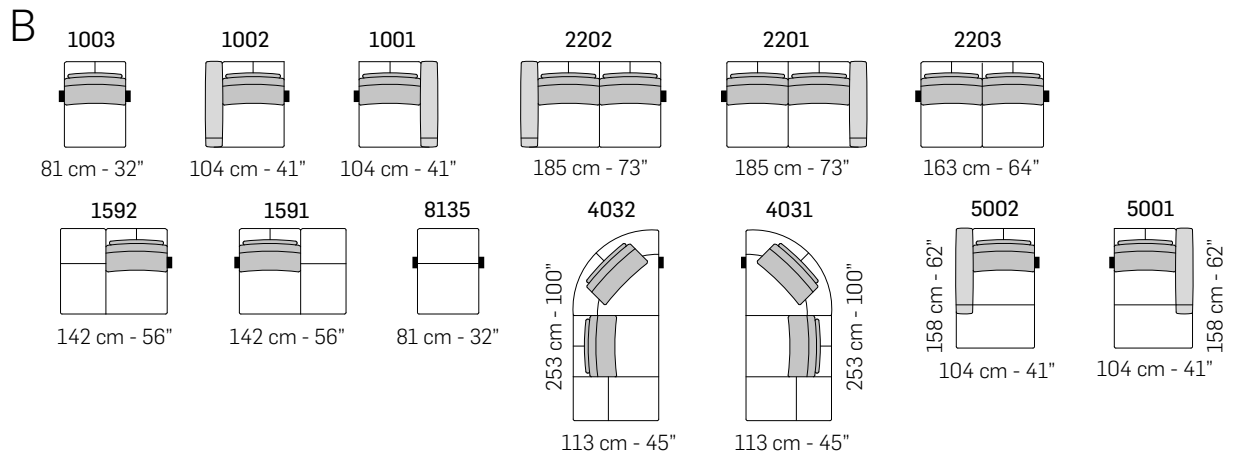

tutti gli elementi del gruppo B hanno lo stesso modulo di seduta - all items in group B have the same seat width

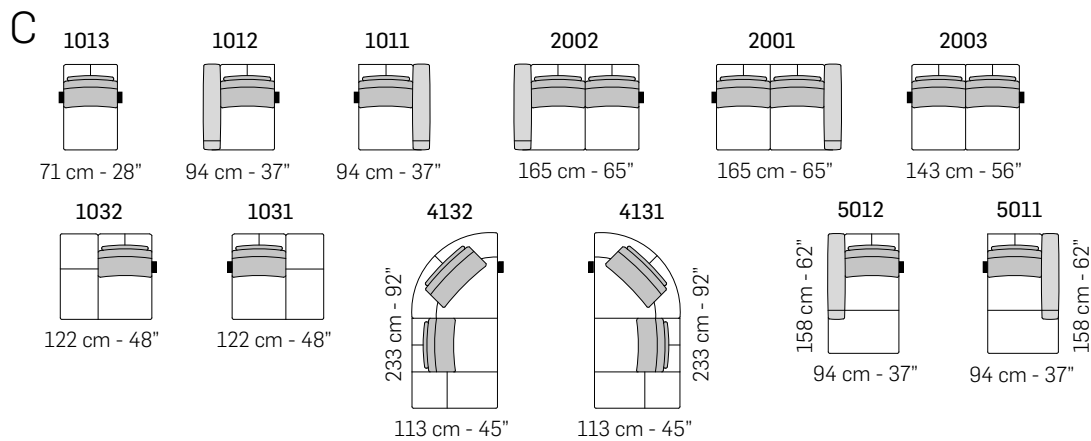

tutti gli elementi del gruppo C hanno lo stesso modulo di seduta - all items in group C have the same seat width

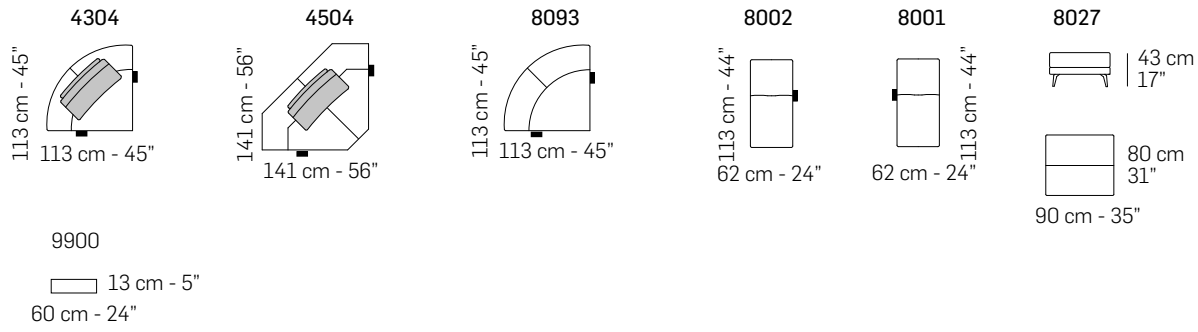

COMPOSIZIONI CONSIGLIATE / SUGGESTED COMPOSITIONS

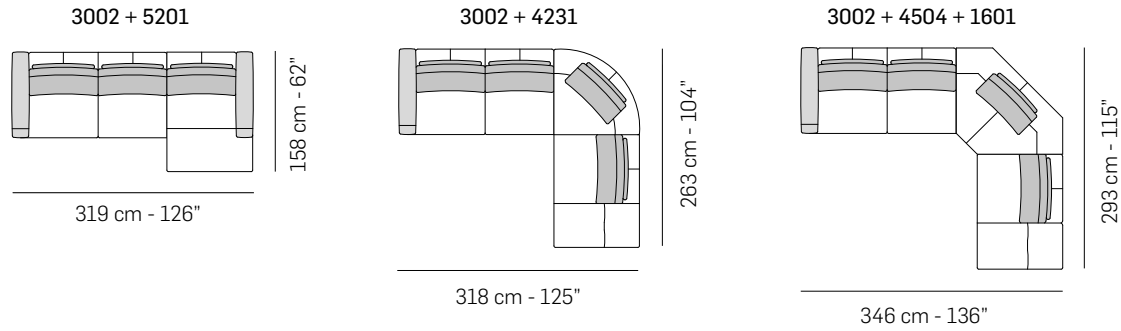

Scala 1:100  
Ratio 1 to 100

Legenda / Legend

- Spalliera / Back Cushions
- Bracciolo / Armrest
- Aggancio Componibile / Connector
- Poggiareni / Kidneyrest
- Seduta / Seat Cushions

Note / Notes

Nicoline si riserva il diritto di apportare in ogni momento modifiche tecniche ed estetiche / Nicoline reserves the right to change, at any time and without prior warning, technical and aesthetic specifications of the articles.



# PAPILLON

Design Application N° BA20130000022



Frontale/Front



Laterale/Depth

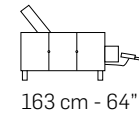
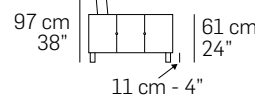
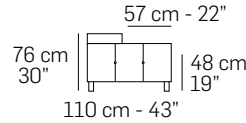

## Caratteristiche standard

- Struttura in legno e multistrato. Molleggio seduta con cinghie elastiche.
- Imbottiture in poliuretano espanso ecologico a cellula aperta con densità differenziate.
- Rivestimento in pelle o tessuto. Tutti i rivestimenti sono fissi.
- Versioni recliner con meccanismo elettrico per la seduta.
- Tutte le versioni contrassegnate dal simbolo "↑", sono dotate di poggiatesta regolabile manualmente.
- Piedi in metallo Lucido (Cod.30), Satinato (Cod.31), Canna di fucile (Cod.50).
- Cucitura Cod.01 per la parte frontale bracciolo. Le restanti cuciture, Cod.03 sia per rivestimento in pelle che per tessuto.
- Inserimento letto non possibile.
- Lato componibile non rifinito.

## Caratteristiche optional su richiesta senza maggiorazione

- Disponibile con cucitura a contrasto, per la scelta del colore fare riferimento ai codici del campionario pelli.

## Caratteristiche optional su richiesta con maggiorazione

- Batteria al litio per movimentare il meccanismo in assenza di elettricità. Considerare una batteria per ogni seduta recliner.
- Solo per le versioni dove previsto, il lato componibile può essere rifinito.
- Per il multi rivestimento il prezzo va incrementato del 7%. Per maggiori dettagli fare riferimento al paragrafo "NOTE" posto nelle prime pagine del listino.

## Note

- Le versioni recliner sono consegnate a moduli separati.
- Non è possibile applicare altre cuciture.
- Per alcuni tessuti e velluti l'azienda si riserva di applicare la cucitura Cod.00 / Cod.03 (vedi immagine).

## Standard features

- Frame: wooden structure, seat suspensions in reinforced elastic webbing.
- Paddings in eco-friendly open cell polyurethane foam, with different densities.
- Covering in leather or fabric. Not removable coverings.
- Reclining versions with electric mechanism for seat.
- All the versions marked by the symbol "↑" are equipped with manual adjustable headrest.
- Metal legs in Shiny (Cod.30), Satin (Cod.31), Gunmetal (cod.50).
- Stitching type Cod.01 for frontal part of the arm. Remaining stitching Cod.03 for leather and fabric coverings.
- No bed version available.
- Sectional sides not finished.

## Optional features available upon request without any upcharge

- Stitching, unless differently requested, will be matching the leather or fabric colour. Contrast stitching colour can be ordered at no extra charge. You might use as reference any Nicoline leather.

## Optional features available upon request with upcharge

- Lithium battery to move the mechanism in the absence of electricity. Please consider one battery per recliner version.
- Sectional sides finished (if possible).
- 7% upcharge for combined coverings. Please refer to the notes at the beginning of pricelist.

## Notes

- All reclining versions are made and delivered as separate elements.
- Different stitchings not available.
- For some fabrics and velvets production dept. must apply the stitching Cod.00 / Cod. 03 (as per picture below).

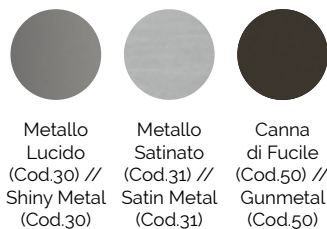

Piede in metallo //  
Metal leg

Cuciture //  
Stitching

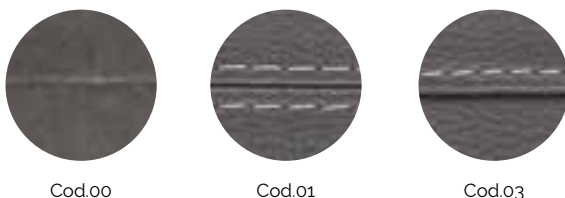

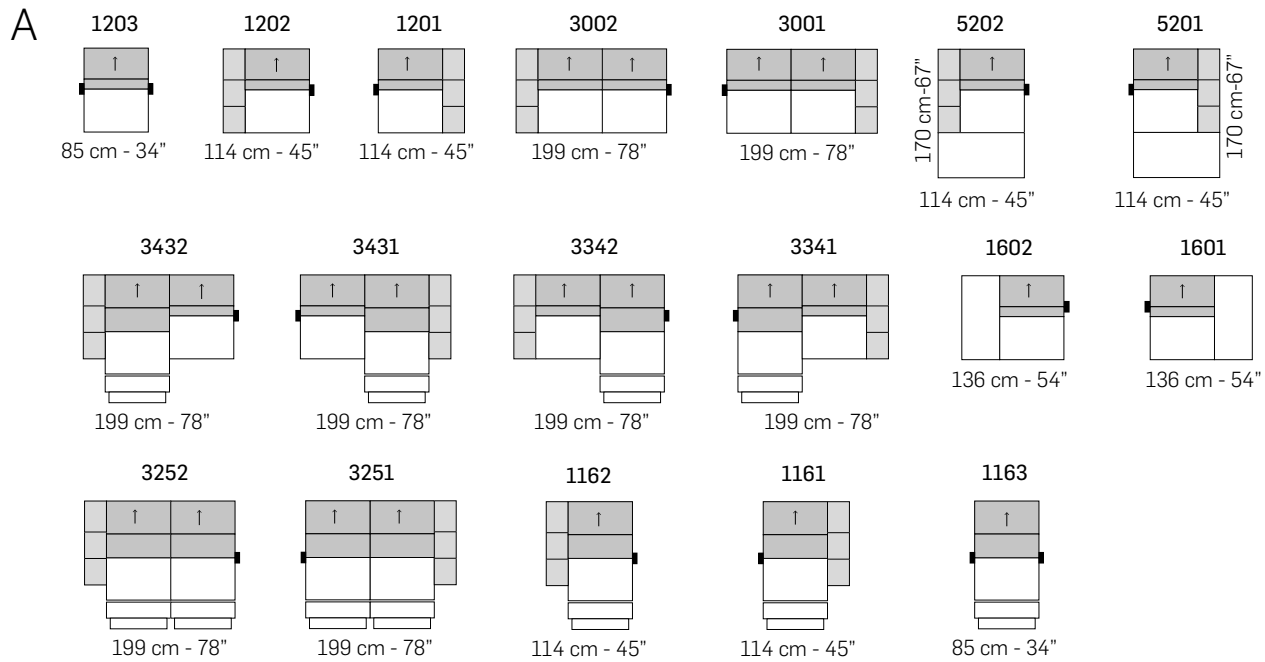
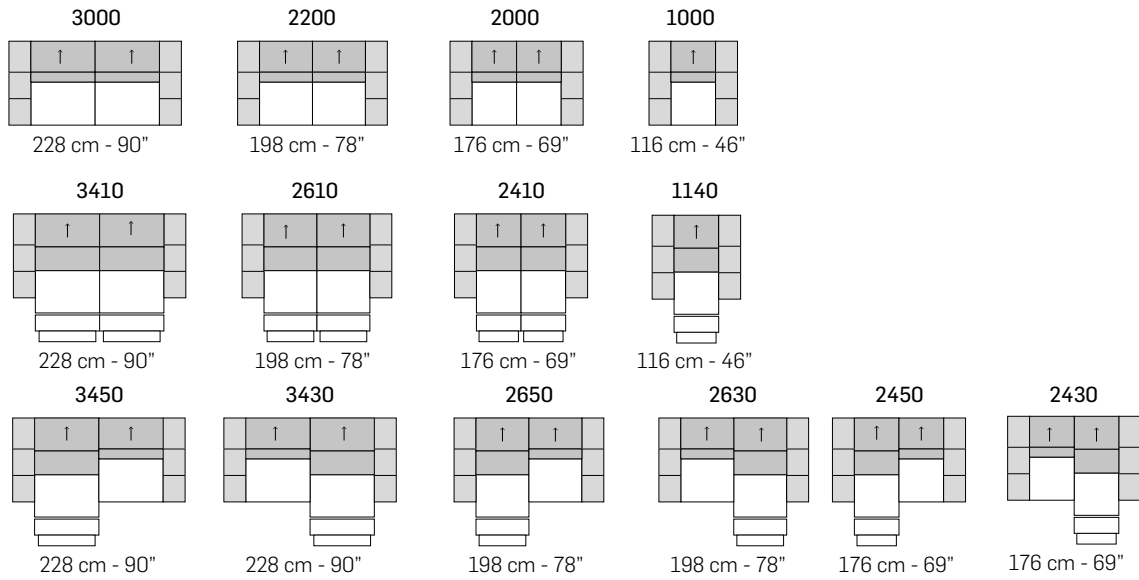

tutti gli elementi del gruppo A hanno lo stesso modulo di seduta - all items in group A have the same seat width

**B**

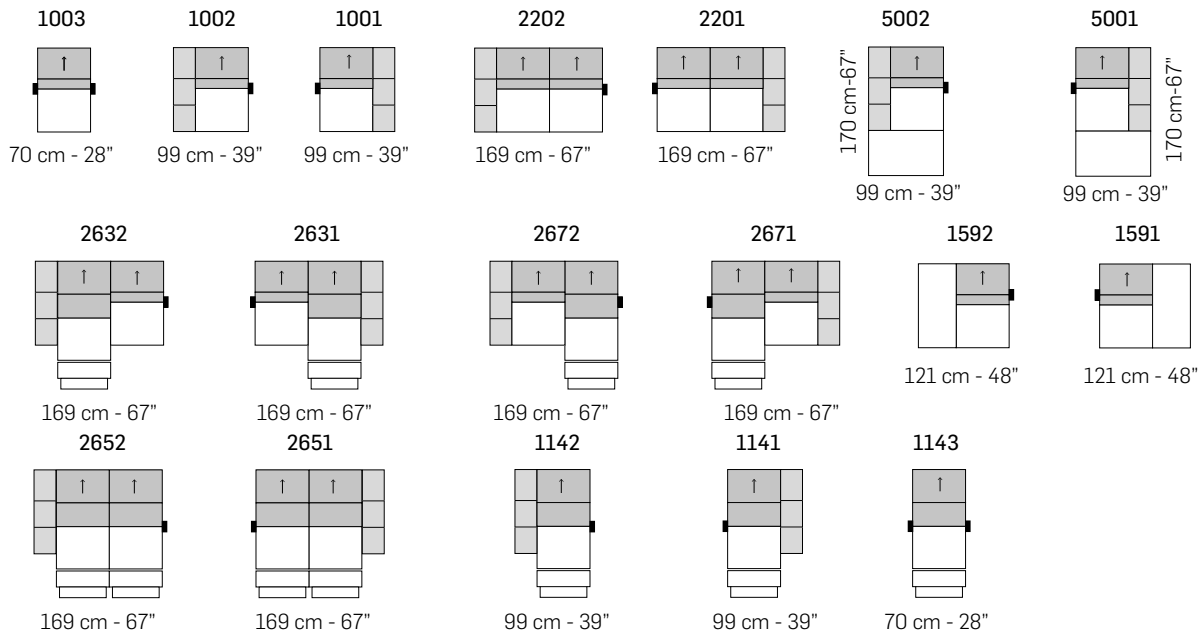

tutti gli elementi del gruppo B hanno lo stesso modulo di seduta - all items in group B have the same seat width

**C**

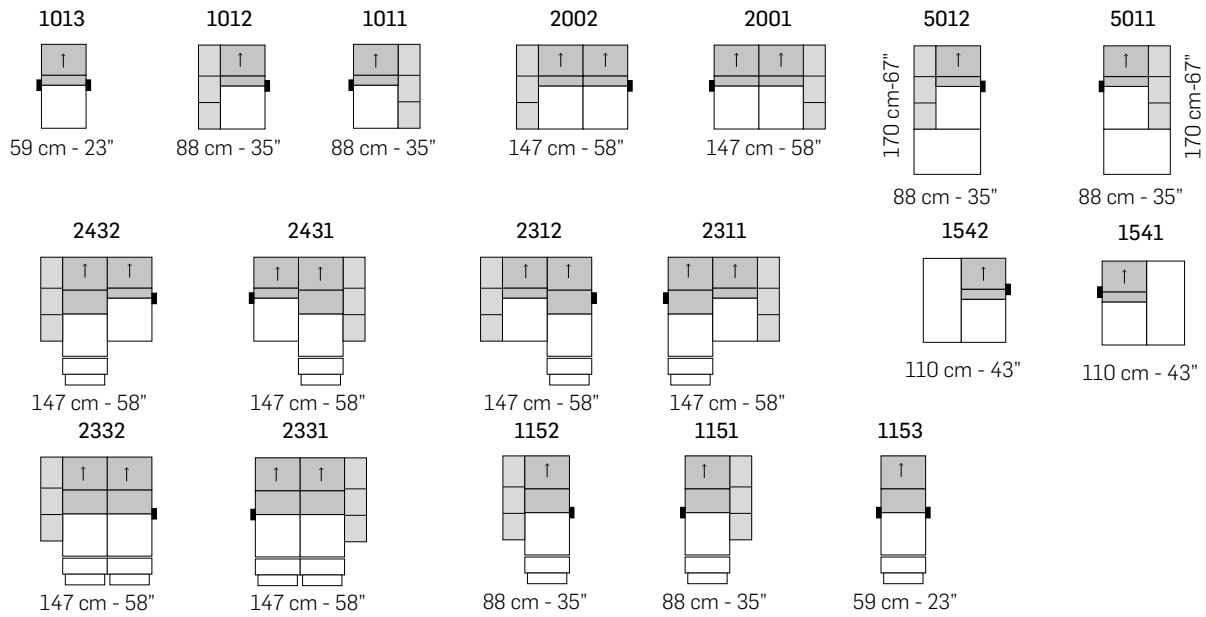

tutti gli elementi del gruppo C hanno lo stesso modulo di seduta - all items in group C have the same seat width

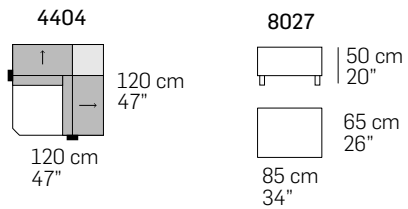



COMPOSIZIONI CONSIGLIATE / SUGGESTED COMPOSITIONS

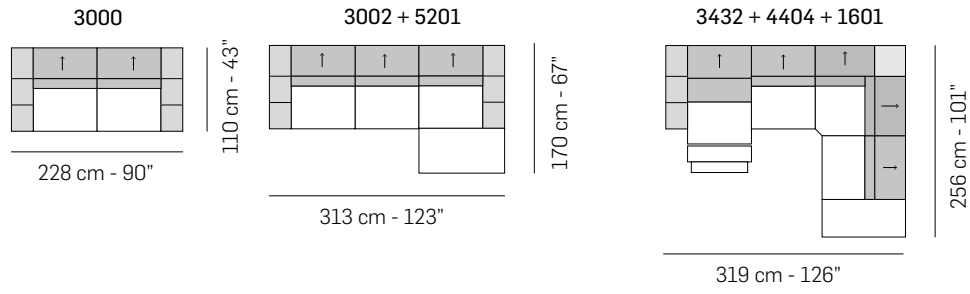

Scala 1:100

Legenda / Legend

- Spalliera / Back Cushions
- Bracciolo / Armrest
- Aggancio Componibile / Connector
- Poggiareni / Kidneyrest
- Seduta / Seat Cushions
- ↑ Poggiatesta regolabile / Adjustable headrest

Note / Notes

Nicoline si riserva il diritto di apportare in ogni momento modifiche tecniche ed estetiche / Nicoline reserves the right to change, at any time and without prior warning, technical and aesthetic specifications of the articles.

# PISA

Design Application N° 402020000002749

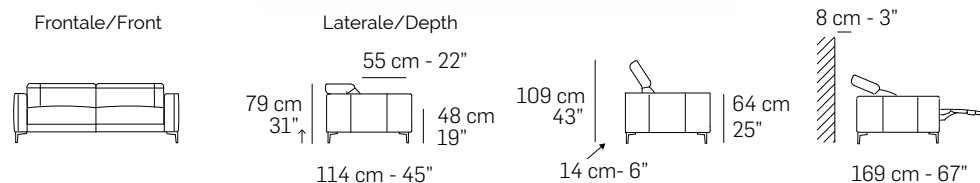

## Caratteristiche standard

- Struttura in legno e multistrato. Molleggio seduta e spalliera con cinghie elastiche.
- Imbottiture in poliuretano espanso ecologico a cellula aperta con densità differenziate.
- Rivestimento in pelle o tessuto. Tutti i rivestimenti sono fissi.
- Versioni recliner con meccanismo elettrico indipendente sia per la seduta sia per il poggiatesta.
- Versioni fisse con meccanismo poggiatesta manuale regolabile.
- Tutte le versioni contrassegnate dal simbolo '^', sono dotate di poggiatesta regolabile.
- Piedi in metallo Lucido (Cod.30), Satinato (Cod.31), Canna di fucile (Cod.50), Bronzo anticato (Cod.52).
- Cuciture per rivestimento in pelle: Cod.219 per bracciolo e centrale spalliera. Cucitura Cod.19 per perimetro spalliera.
- Cucitura Cod.19 per rivestimento in tessuto.
- Inserimento letto non possibile.
- Lato componibile non rifinito.

## Caratteristiche optional su richiesta senza maggiorazione

- Disponibile con cucitura a contrasto, per la scelta del colore fare riferimento ai codici del campionario pelli.

## Caratteristiche optional su richiesta con maggiorazione

- Batteria al litio per movimentare il meccanismo in assenza di elettricità. Considerare una batteria per ogni seduta recliner.
- Solo per le versioni dove previsto, il lato componibile può essere rifinito.
- Per il multi rivestimento il prezzo va incrementato del 7%. Per maggiori dettagli fare riferimento al paragrafo "NOTE" posto nelle prime pagine del listino.

## Note

- Le versioni recliner sono consegnate a moduli separati.
- Non è possibile applicare altre cuciture.
- Per alcuni tessuti e velluti l'azienda si riserva di applicare la cucitura Cod.00 / Cod.03 (vedi immagine).

## Standard features

- Frame: wooden structure, seat suspensions in reinforced elastic webbing.
- Paddings in eco-friendly open cell polyurethane foam, with different densities.
- Covering in leather or fabric. Not removable coverings.
- Electrical independent mechanism both on the footrest and headrest for reclining versions.
- Manually adjustable headrest for stationary versions.
- All the versions marked by the symbol '^' are equipped with electrical adjustable headrest.
- Metal legs in Shiny (Cod.30), Satin (Cod.31), Gunmetal (Cod.50), Antique Bronze (Cod.52).
- Stitching type Cod.219 for leather covering, for armrest and central backrest. Stitching type Cod.19 for backrest perimeter.
- Stitching type Cod.19 for fabric covering.
- Folding bed not available.
- Sectional sides are finished.

## Optional features available upon request with no upcharge

- Stitching, unless differently requested, will be matching the leather or fabric colour. Contrast stitching colour can be ordered at no extra charge. You might use as reference any Nicoline leather.

## Optional features available upon request with an upcharge

- Lithium battery to move the mechanism in the absence of electricity. Please consider one battery per recliner version.
- Sectional sides finished (if possible).
- 7% upcharge for combined coverings or patterned fabrics. Please refer to the notes at the beginning of pricelist.

## Notes

- All reclining versions are made and delivered as separate elements.
- Different stitchings not available.
- For some fabrics and velvets production dept. must apply the stitching Cod.00 / Cod.03 (as per picture below).



Piede in metallo // Metal leg

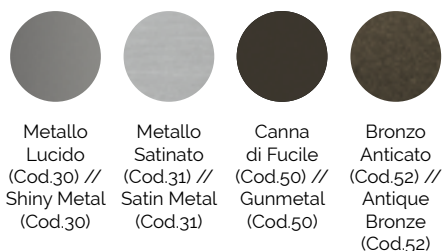

Cuciture // Stitching

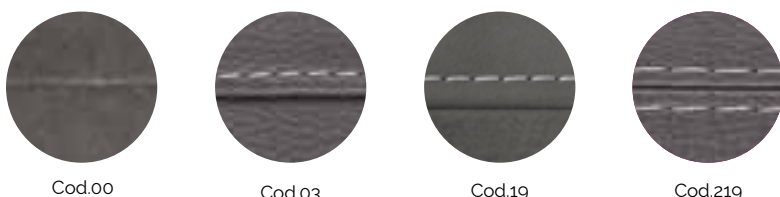

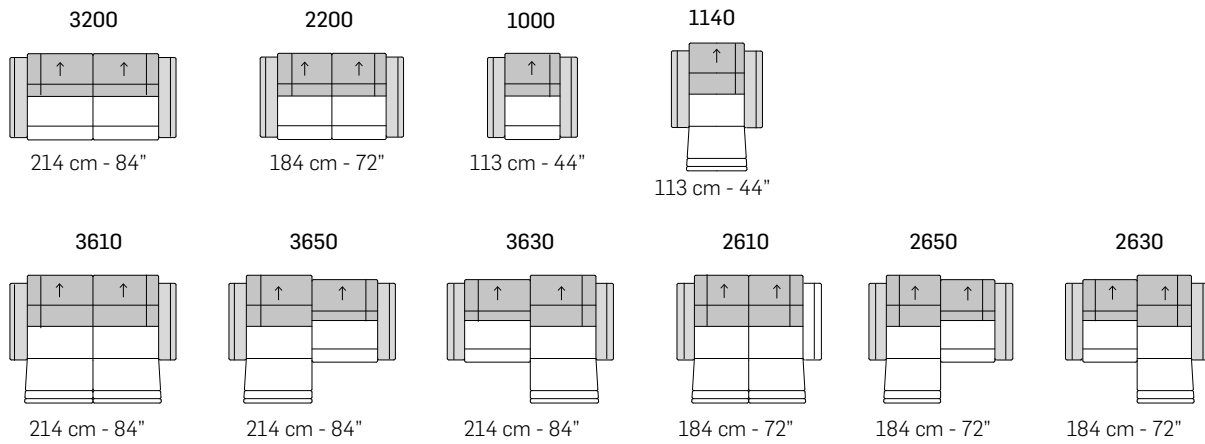

A

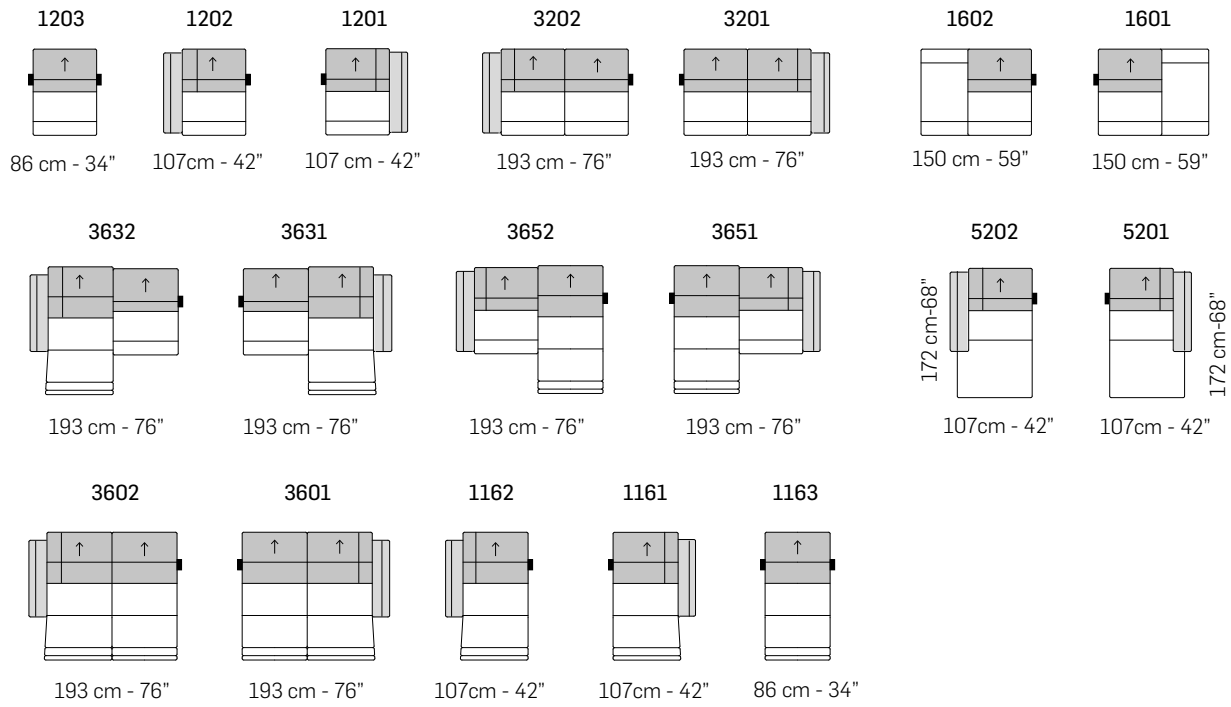

tutti gli elementi del gruppo A hanno lo stesso modulo di seduta - all items in group A have the same seat width

B

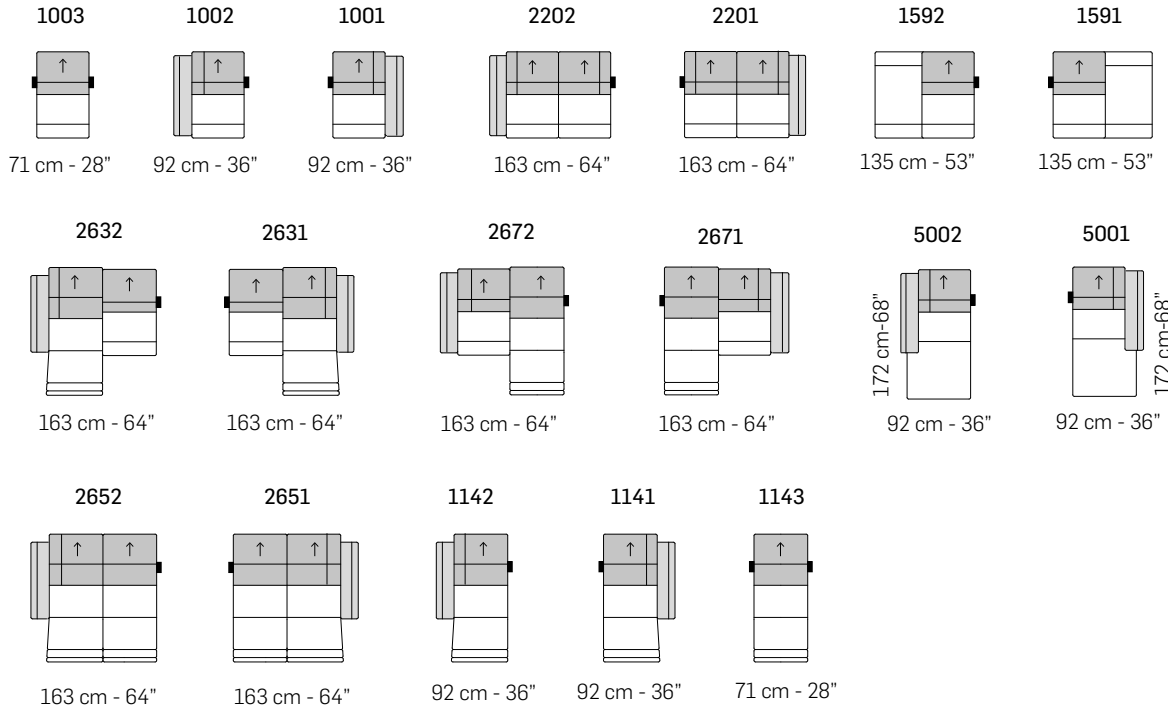

tutti gli elementi del gruppo B hanno lo stesso modulo di seduta - all items in group B have the same seat width

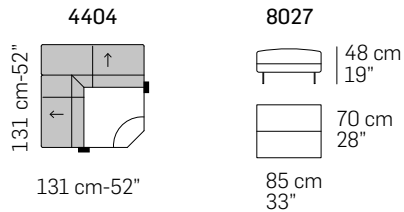

COMPOSIZIONI CONSIGLIATE / SUGGESTED COMPOSITIONS

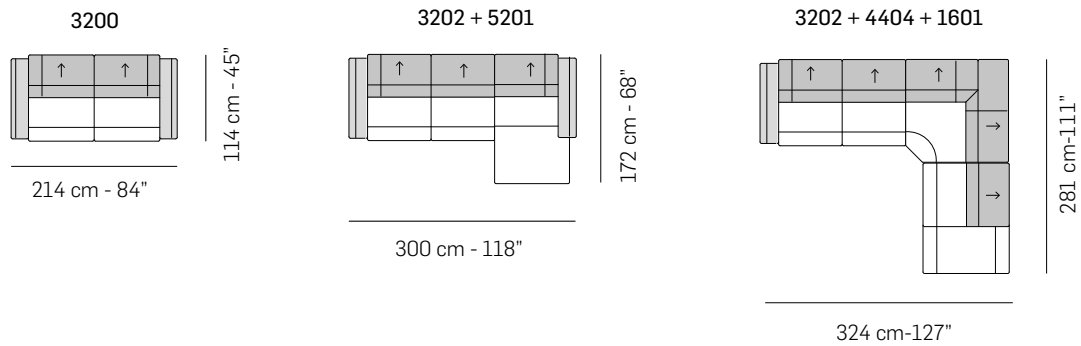

Scala 1:100  
Ratio 1 to 100

Legenda / Legend

- Spalliera / Back Cushions
- Bracciolo / Armrest
- Poggiatesta regolabile / Adjustable headrest
- Aggancio Componibile / Connector
- Poggiaresi / Kidneyrest
- Seduta / Seat Cushions

Note / Notes

Nicoline si riserva il diritto di apportare in ogni momento modifiche tecniche ed estetiche / Nicoline reserves the right to change, at any time and without prior warning, technical and aesthetic specifications of the articles.



# SHELLEY

Design Application N°402016000053464



Frontale/Front

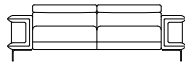

Laterale/Depth

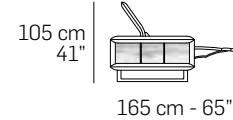
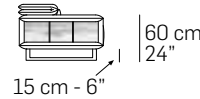
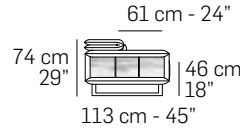

## Caratteristiche standard

- Struttura in legno e multistrato. Molleggio seduta e spalliera con cinghie elastiche.
- Imbottiture in poliuretano espanso ecologico a cellula aperta con densità differenziate.
- Rivestimento in pelle o tessuto. Tutti i rivestimenti sono fissi.
- Versioni recliner con meccanismo elettrico indipendente sia per la seduta che per il poggiatesta.
- Versioni fisse con meccanismo poggiatesta manuale ad unica posizione e azionato da pistone a gas.
- Piedi in metallo Lucido (Cod.30), Satinato (Cod.31), Canna di fucile (Cod.50), Bronzo anticato (Cod.52).
- Libreria interno bracciolo in legno verniciata nei colori RAL opaco: RAL 7006 - RAL 7024 - RAL 7044 - RAL 8019.
- Elemento prisma (Cod.8100) dotato di vano contenitore con coperchio/vassoio removibile e vano portariviste con doppio ingresso USB. Disponibili in legno verniciati nei colori RAL opaco: RAL 7006 - RAL 7024 - RAL 7044 - RAL 8019.
- Inserimento letto non possibile.
- Lato componibile non rifinito.

## Caratteristiche optional su richiesta con maggiorazione

- Batteria al litio per movimentare il meccanismo in assenza di elettricità. Considerare una batteria per ogni seduta recliner.
- Solo per le versioni dove previsto, il lato componibile può essere rifinito.
- Per il multi rivestimento il prezzo va incrementato del 7%. Per maggiori dettagli fare riferimento al paragrafo "NOTE" posto nelle prime pagine del listino.

## Note

- Le versioni recliner sono consegnate a moduli separati

## Standard features

- Frame: wooden structure, seat and back suspensions in reinforced elastic webbing.
- Paddings in eco-friendly open cell polyurethane foam with different densities.
- Covering in leather or fabric. Not removable coverings.
- Electrical independent mechanism both on the footrest and headrest for reclining versions.
- Manual adjustable headrest with hydraulic cylinders, for fixed versions.
- Legs in Shiny metal (Cod.30), Satin metal (Cod.31), Gunmetal (Cod.50), Antique bronze (Cod.52).
- Arm with wooden bookcase painted in the following matte RAL colors: RAL 7006 - RAL 7024 - RAL 7044 - RAL 8019.
- Prism element (Cod.8100) equipped with storage compartment with removable top/tray and magazine rack with double USB port. Available painted in the following matte RAL colors: RAL 7006 - RAL 7024 - RAL 7044 - RAL 8019.
- No bed version available.
- Sectional sides not finished.

## Optional features available upon request with upcharge

- Lithium battery kit available. One battery pack for each reclining seat.
- Sectional sides finished (if possible).
- 7% upcharge for combined coverings. Please refer to the notes at the beginning of pricelist.

## Notes

- All reclining versions are made and delivered as separate elements.



Piede in metallo // Metal leg

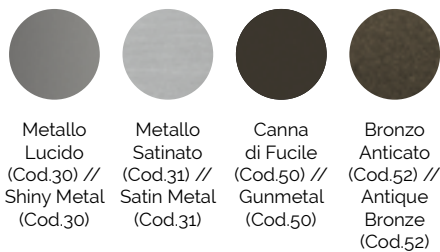

Libreria // Bookcase

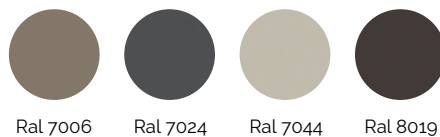

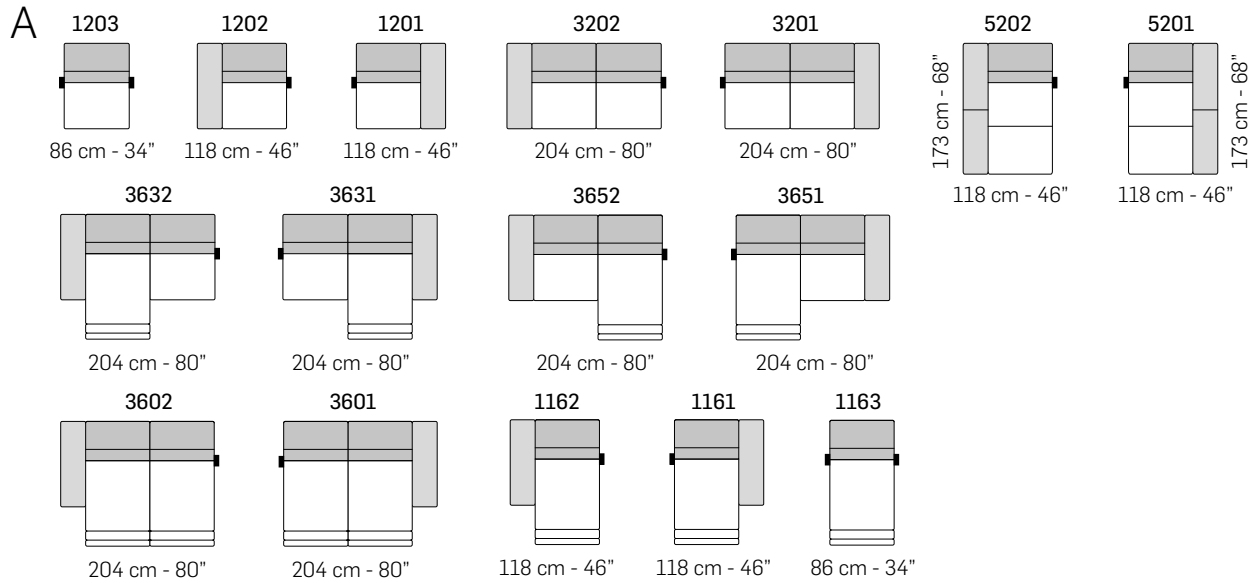
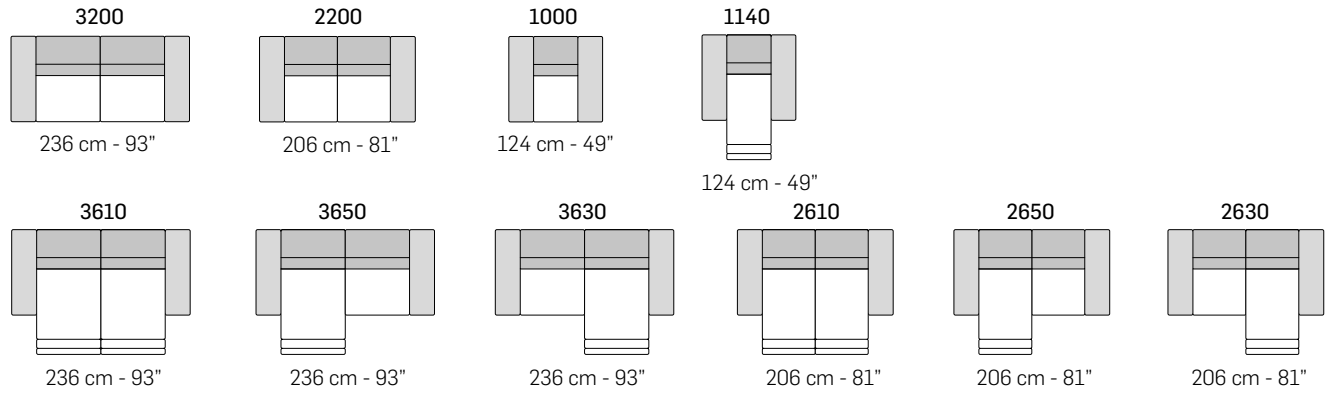

tutti gli elementi del gruppo A hanno lo stesso modulo di seduta - all items in group A have the same seat width

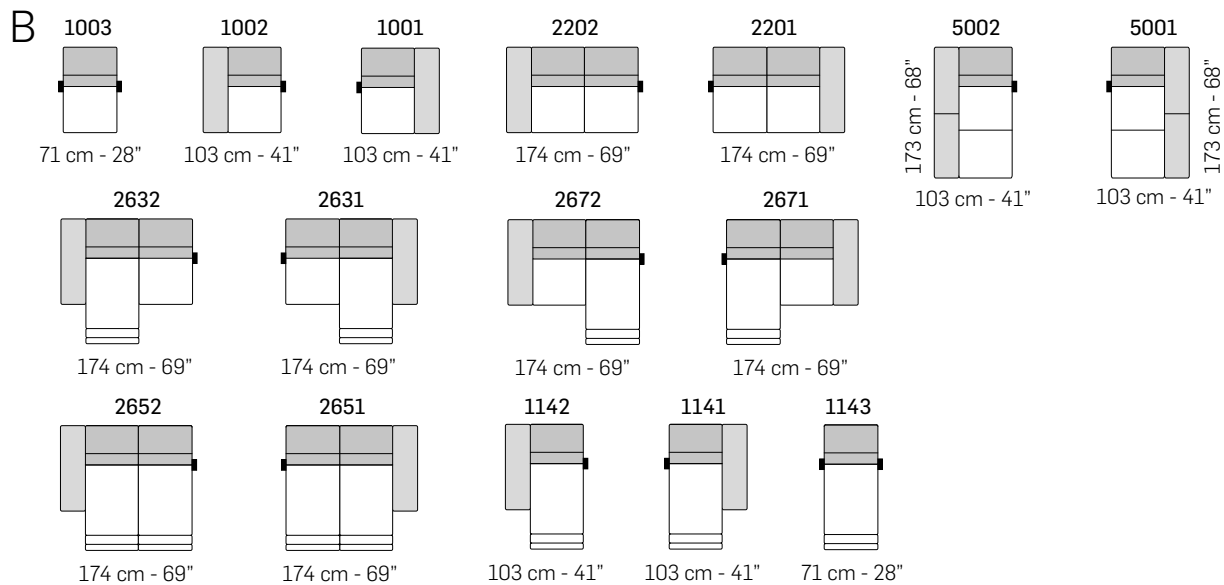

tutti gli elementi del gruppo B hanno lo stesso modulo di seduta - all items in group B have the same seat width

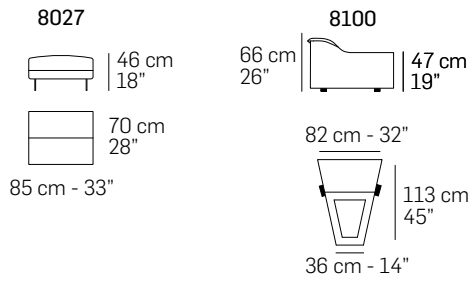

COMPOSIZIONI CONSIGLIATE / SUGGESTED COMPOSITIONS

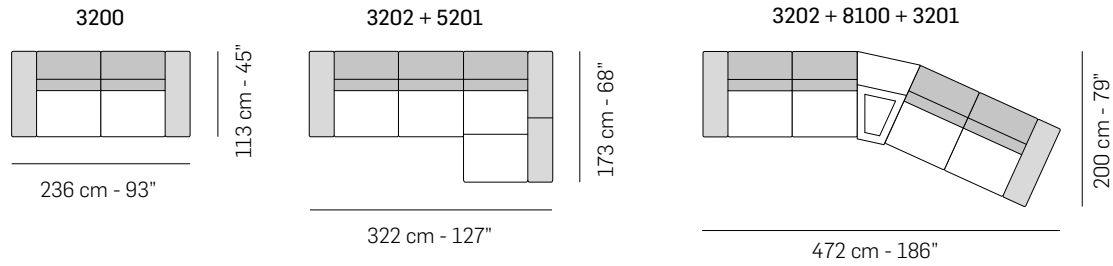

Scala 1:100  
Ratio 1 to 100

Legenda / Legend

- Spalliera / Back Cushions
- Bracciolo / Armrest
- Aggancio Componibile / Connector
- Poggiareni / Kidneyrest
- Seduta / Seat Cushions

Note / Notes

Nicoline si riserva il diritto di apportare in ogni momento modifiche tecniche ed estetiche / Nicoline reserves the right to change, at any time and without prior warning, technical and aesthetic specifications of the articles.





# SIRIO

Design Application N° 40202000002749



frontale // front

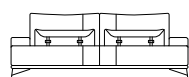

laterale // depth

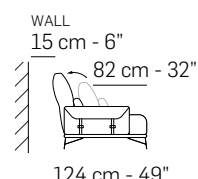
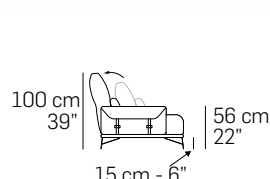
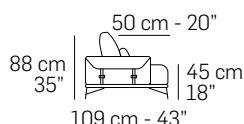

## Caratteristiche standard

- Struttura in legno e multistrato con supporto in metallo, molleggio seduta e schienale con cinghie elastiche.
- Imbottiture in poliuretano espanso ecologico a cellula aperta con densità differenziate.
- Rivestimento in pelle o tessuto. Tutti i rivestimenti sono fissi, ad eccezione del cuscinetto lombare che è removibile.
- Piede (PM001) in metallo Canna di fucile (Cod.50), Bronzo anticato (Cod.52), entrambe le finiture hanno la parte inferiore verniciata in colore oro satinato.
- Fibbia bracciolo in metallo Canna di fucile (Cod.CF).
- I cuscini di schienale sono dotati di meccanismo regolabile che permette di aumentare l'altezza dello stesso, oltre che la profondità della seduta.
- Cucitura Cod.01 per seduta e parte centrale spalliera, solo rivestimento in pelle.
- Cucitura Cod.03 per fianco spalliera, sia in pelle che in tessuto.
- Cucitura Cod.019 per bracciolo e cuscinetto lombare, sia in pelle che in tessuto.
- Inserimento letto non possibile.
- Lato componibile rifinito.

## Caratteristiche optional su richiesta senza maggiorazione

- Piede (PM002) in metallo Canna di fucile (Cod.50), Bronzo anticato (Cod.52).
- Disponibile con cucitura a contrasto, per la scelta del colore fare riferimento ai codici del campionario pelli.
- Nessuna maggiorazione in caso di scelta dei laccetti in pelle di un colore differente dal rivestimento principale.

## Caratteristiche optional su richiesta con maggiorazione

- Per il multi rivestimento il prezzo va incrementato del 7%. Per maggiori dettagli fare riferimento al paragrafo "NOTE" posto nelle prime pagine del listino.
- Cuscino lombare Cod.9802 e Cod.9801 realizzati con imbottitura in poliuretano espanso ecologico a cellula aperta.
- Ogni versione comprende un numero di cuscini di schienale pari a quanto riportato nello stesso schema (disegno versione). Eventuali cuscini supplementari potranno essere ordinati singolarmente. Vedi Cod.9802 e Cod.9801.

## Note

- I laccetti possono essere realizzati solamente in pelle.
- I disegni grafici che riportano l'asterisco (\*) sono sempre con lato rifinito e anche agganciabili agli elementi componibili.
- Non è possibile applicare altre cuciture.
- Per alcuni tessuti e velluti l'azienda si riserva di applicare la cucitura Cod.00 / Cod.03 (vedi immagine).

## Standard features

- Frame: wooden structure with metal support, seat and back suspensions in reinforced elastic webbing.
- Paddings in eco-friendly open cell polyurethane foam, with different densities.
- Covering in leather or fabric. Not removable coverings except for the lumbar cushion.
- Legs (PM001) in Gunmetal (Cod.50), Antique Bronze (Cod.52), both finishes with lower part painted in matte gold color.
- Armrest buckle in Gunmetal (Cod.CF).
- Back cushions with adjustable mechanism that allows to increase the height of the backrest and the depth of the seat.
- Stitching type Cod.01 on the seat and central part of backrest for leather covering.
- Stitching Cod.03 on the backrest side for both leather and fabric covering.
- Stitching Cod.019 on the armrest and lumbar cushion for both leather and fabric covering.
- No bed version available.
- Sectional sides finished.

## Optional features available upon request with no upcharge

- Legs (PM002) in Gunmetal (Cod.50), Antique Bronze (Cod.52).
- Stitching, unless differently requested, will be matching the leather or fabric colour. Contrast stitching colour can be ordered at no extra charge. You might use as reference any Nicoline leather.
- No upcharge in case of choice of leather laces in a different colour from the main covering.

## Optional features available upon request with an upcharge

- 7% upcharge for combined coverings. Please refer to the notes at the beginning of pricelist.
- Lumbar Cushion Cod. 9802 and 9801 made with eco-friendly open cell polyurethane foam padding.
- Each version includes a certain number of back cushions as shown in the version drawing. Any additional cushions can be ordered individually. Please consider cushions cod.9802 and Cod.9801.

## Notes

- The laces can only be made of leather.
- Versions with asterisk (\*) have always the terminal side finished with the possibility to be connected to modular elements.
- Different stitching not available.
- For some fabrics and velvets production dept. must apply the stitching Cod.00 / Cod.03 (as per picture below).



Canna di Fucile (Cod.50) /  
Oro satinato //  
Gunmetal (Cod.50) /  
Matte Gold color



Bronzo Anticato (Cod.52) /  
Oro satinato //  
Antique Bronze (Cod.52) /  
Matte Gold color

Piede in metallo (PM001) //  
Metal leg (PM001)



Canna di Fucile  
(Cod.50) //  
Gunmetal  
(Cod.50)



Bronzo Anticato  
(Cod.52) //  
Antique Bronze  
(Cod.52)

Piede in metallo (PM002) //  
Metal leg (PM002)



Bracciolo con rivestimento  
in tessuto // Armrest with  
fabric covering



Bracciolo con  
rivestimento in pelle //  
Armrest with leather  
covering

Cuciture //  
Stitching



Cod.00

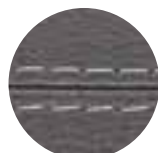

Cod.01

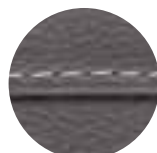

Cod.03



Cod.19

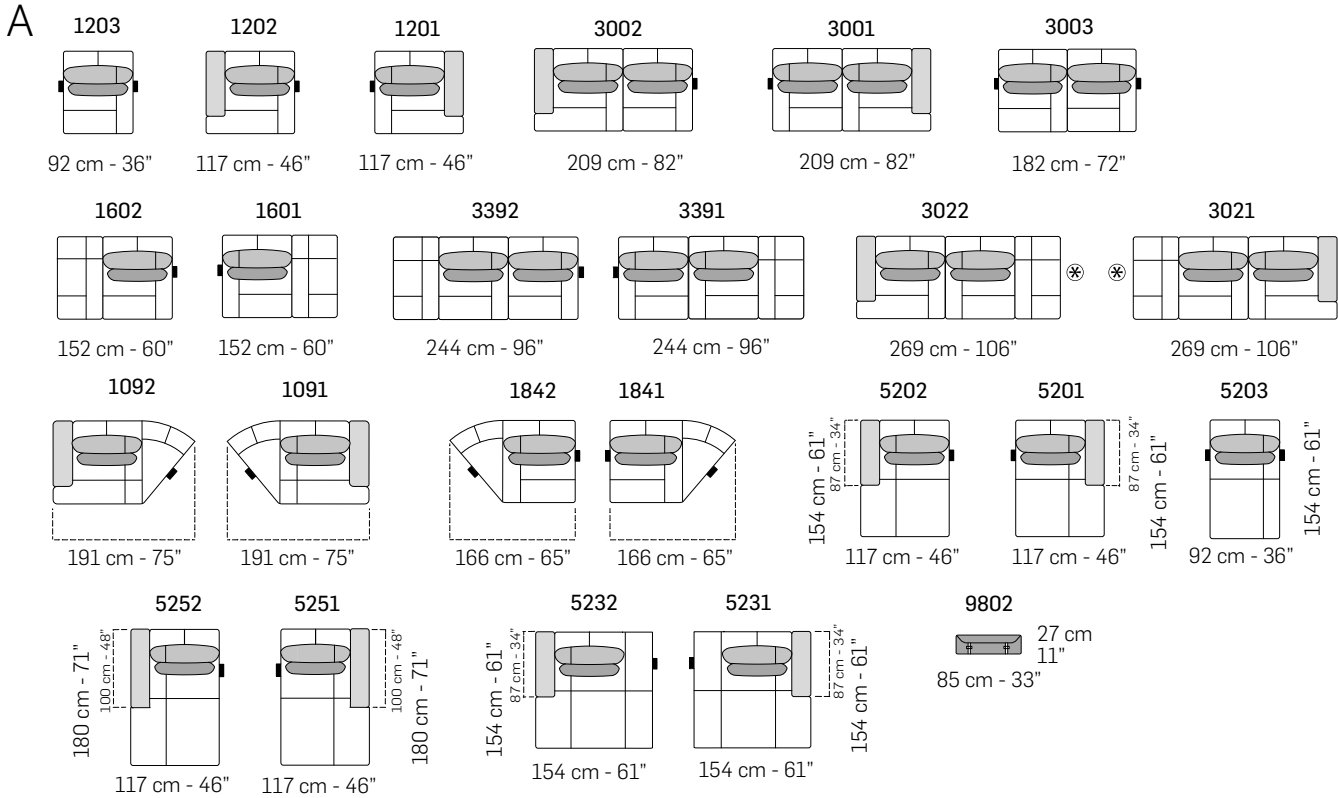
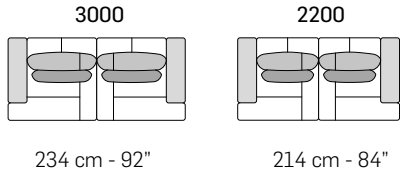

tutti gli elementi del gruppo A hanno lo stesso modulo di seduta - all items in group A have the same seat width

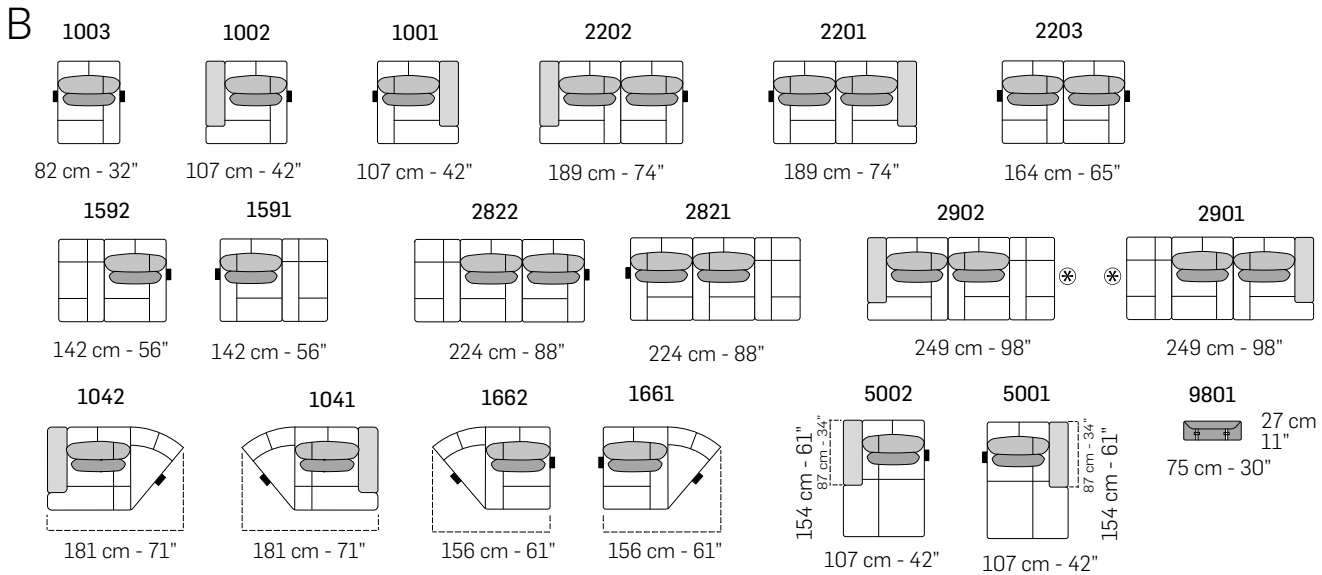

tutti gli elementi del gruppo B hanno lo stesso modulo di seduta - all items in group B have the same seat width

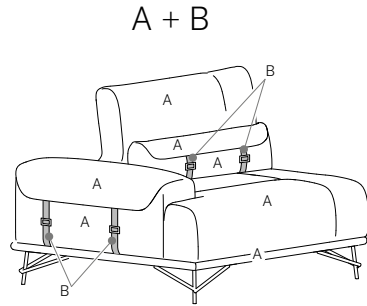
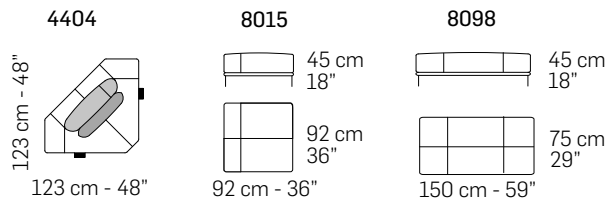

CONFIG.1

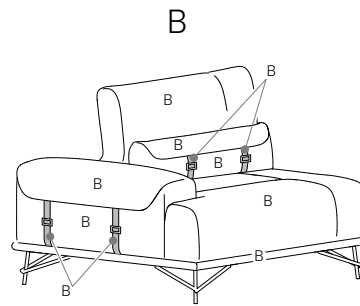

CONFIG.2

Opzioni configurazione divano - Sofa configuration options:

- A: Tessuto / Fabric
- B: Pelle / Leather

COMPOSIZIONI CONSIGLIATE / SUGGESTED COMPOSITIONS

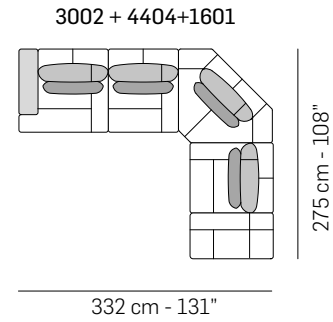
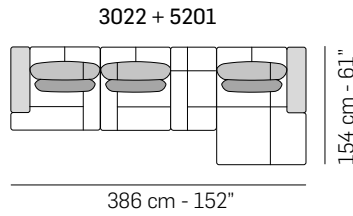
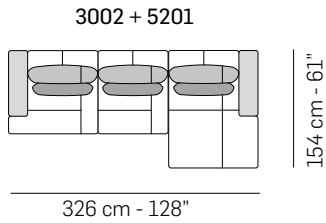

Scala 1:100  
Ratio 1 to 100

Legenda / Legend

- Spalliera / Back Cushions
- Bracciolo / Armrest
- Poggiareni / Kidneyrest
- Seduta / Seat Cushions

⊗ Lato terminale sempre rifinito e agganciabile agli elementi componibili / Terminal side is always finished and it can also be connected to modular elements

■ Aggancio Componibile / Connector

Note / Notes

Nicoline si riserva il diritto di apportare in ogni momento modifiche tecniche ed estetiche / Nicoline reserves the right to change, at any time and without prior warning, technical and aesthetic specifications of the articles.



# TIZIANO

Design Application N° BA20130000017



frontale // front

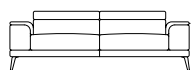

laterale // depth

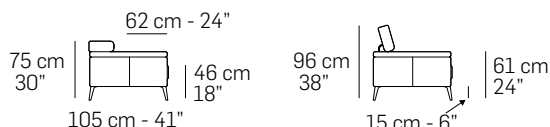

## Caratteristiche standard

- Struttura in legno e multistrato, molleggio seduta con cinghie elastiche.
- Imbottitura in poliuretano espanso ecologico a cellula aperta con densità differenziate.
- Rivestimento in pelle o tessuto. Tutti i rivestimenti sono fissi.
- Rivestimento in pelle con seduta trapuntata.
- Rivestimento in tessuto con seduta senza trapuntatura.
- Tutte le versioni contrassegnate dal simbolo "↑", sono dotate di poggiatesta regolabile manualmente.
- Piede in metallo Lucido (Cod.30), Satinato (Cod.31), Canna di fucile (Cod.50), Bronzo anticato (Cod.52).
- Cucitura Cod.03 per rivestimento in pelle e tessuto.
- Inserimento letto non possibile.
- Lato componibile non rifinito.

## Caratteristiche optional su richiesta senza maggiorazione

- Seduta non trapuntata per versione in pelle.
- Disponibile con cucitura a contrasto, per la scelta del colore fare riferimento ai codici del campionario pelli.

## Caratteristiche optional su richiesta con maggiorazione

- Solo per le versioni dove previsto, il lato componibile può essere rifinito.
- Solo per rivestimento in pelle e con maggiorazione del 10%, disponibile cucitura Cod.11 per schienale, seduta e bracciolo.
- Per il multi rivestimento il prezzo va incrementato del 7%. Per maggiori dettagli fare riferimento al paragrafo "NOTE" posto nelle prime pagine del listino.

## Note

- Non è possibile applicare altre cuciture.
- Non è disponibile la cucitura Cod.11 per tutti i rivestimenti in tessuto.
- Per alcuni tessuti e velluti l'azienda si riserva di applicare la cucitura Cod.00 / Cod.03 (vedi immagine).

## Standard features

- Frame: wooden structure, seat suspensions in reinforced elastic webbing.
- Paddings in eco-friendly open cell polyurethane foam with different densities.
- Covering in leather or fabric. Not removable coverings.
- Quilted seat for leather coverings.
- Not quilted seat for fabric coverings.
- All the versions marked by the symbol "↑" are equipped with manually adjustable headrest.
- Legs in Shiny metal (Cod.30), Satin metal (Cod.31), Gunmetal (Cod.50), Antique bronze (Cod.52).
- Stitching type Cod.03 for leather and fabric coverings.
- No bed version available.
- Sectional sides not finished.

## Optional features without any upcharge

- Not quilted seat for leather coverings.
- Stitching, unless differently requested, will be matching the leather or fabric colour.
- Contrast stitching available. Please refer to our leather collection for a thread color indication.

## Optional features with upcharge

- Sectional sides finished (if possible).
- Just for leather coverings, available stitching Cod.11 for back, seat and armrest. 10% upcharge.
- 7% upcharge for combined coverings. Please refer to the notes at the beginning of pricelist.

## Notes

- Different stitchings not available.
- Stitching Cod.11 not available for all fabric coverings.
- For some fabrics and velvets production dept. must apply the stitching Cod.00 / Cod.03 (as per picture below).

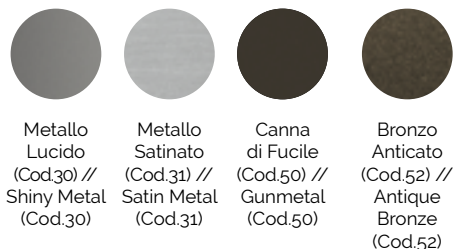

Piede in metallo //  
Metal leg

Cuciture //  
Stitching



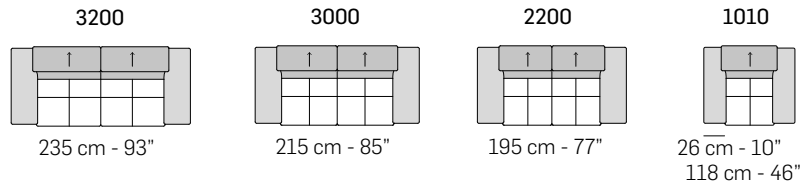

A

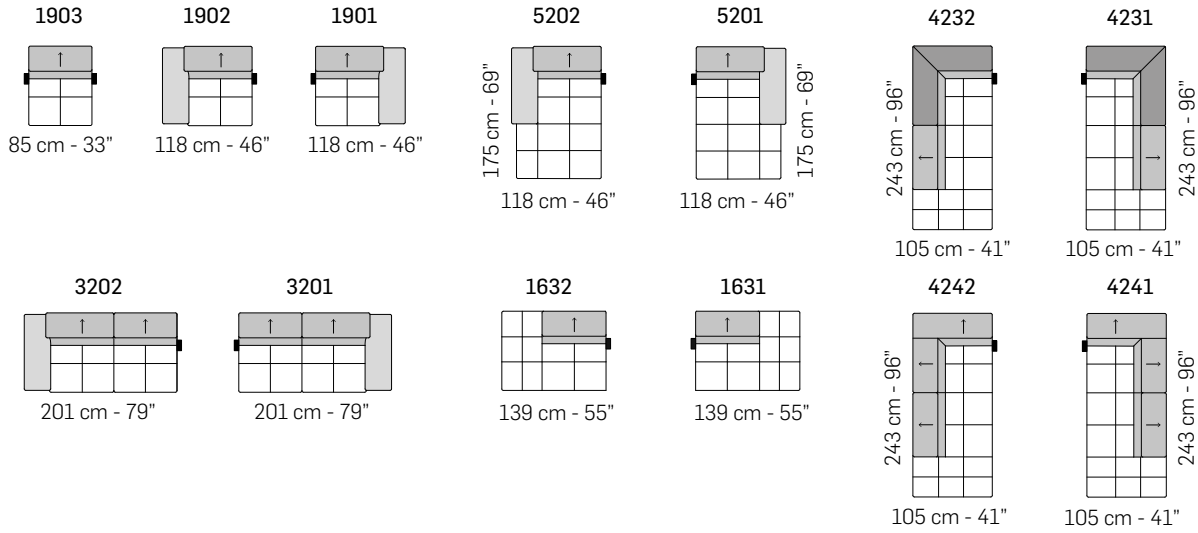

tutti gli elementi del gruppo A hanno lo stesso modulo di seduta - all items in group A have the same seat width

B

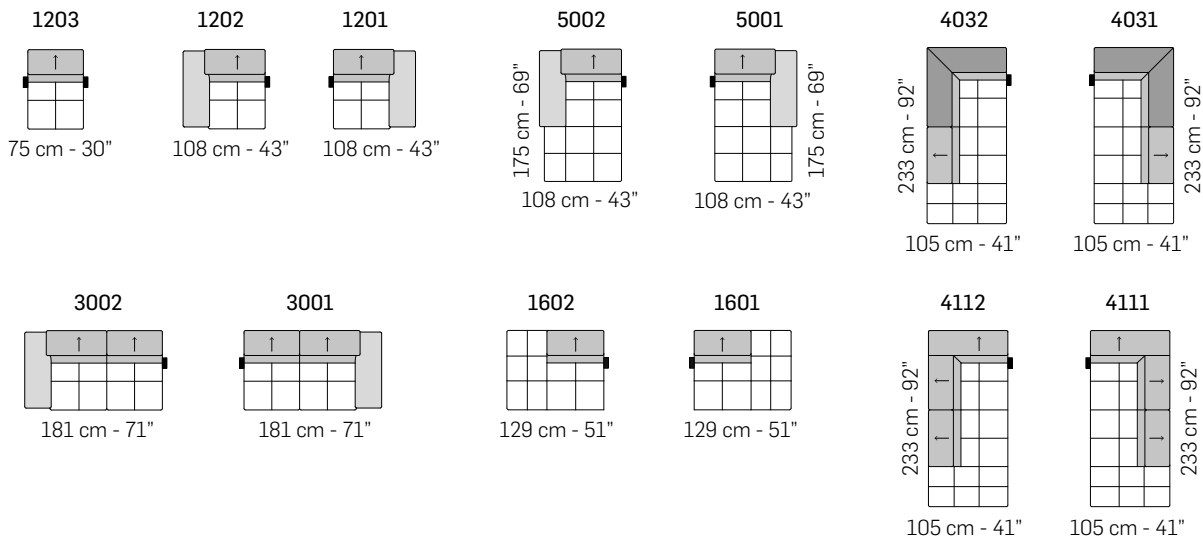

tutti gli elementi del gruppo B hanno lo stesso modulo di seduta - all items in group B have the same seat width

C

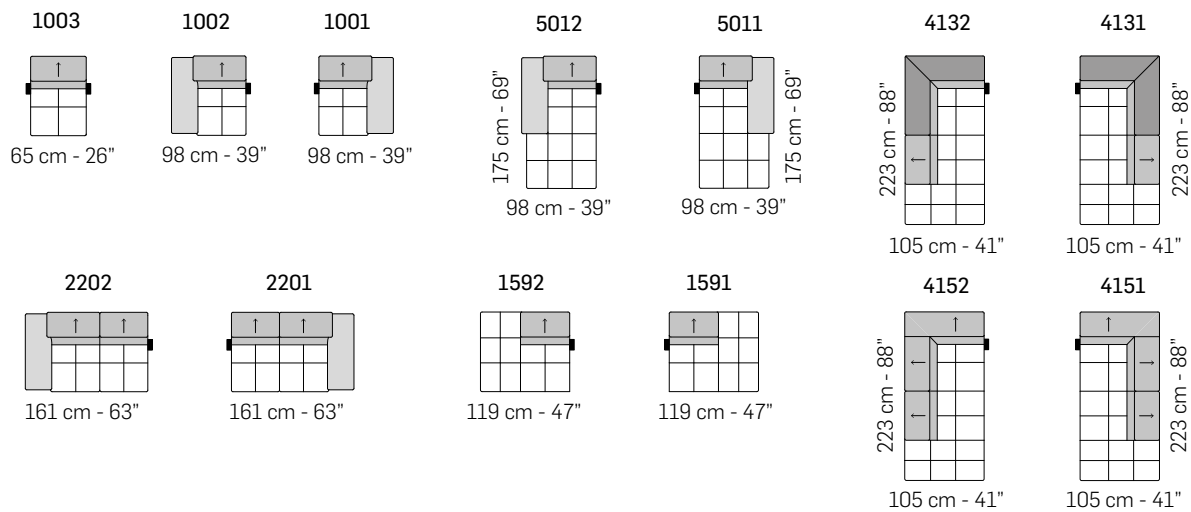

tutti gli elementi del gruppo C hanno lo stesso modulo di seduta - all items in group C have the same seat width

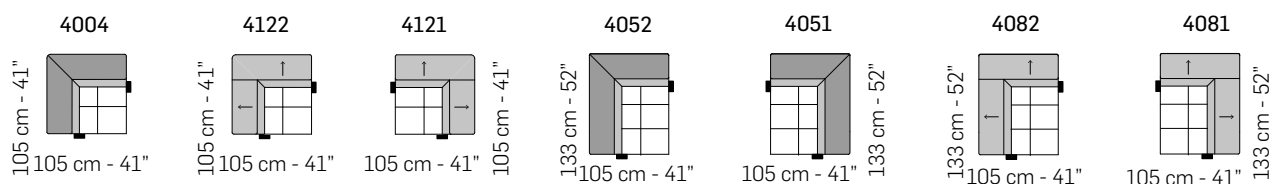

8027

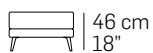

85 cm  
33"

COMPOSIZIONI CONSIGLIATE / SUGGESTED COMPOSITIONS

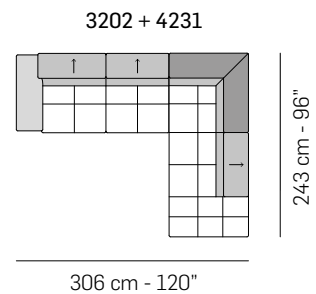
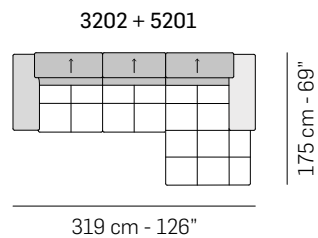
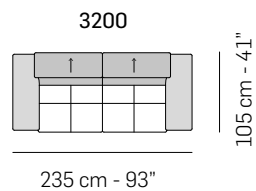

Scala 1:100  
Ratio 1 to 100

Legenda / Legend

- Spalliera / Back Cushions
- Bracciolo / Armrest
- Aggancio Componibile / Connector
- Poggiareni / Kidneyrest
- Seduta / Seat Cushions
- Poggiatesta fisso / Fixed headrest
- ↑ Poggiatesta regolabile / Adjustable headrest

Note / Notes

Nicoline si riserva il diritto di apportare in ogni momento modifiche tecniche ed estetiche / Nicoline reserves the right to change, at any time and without prior warning, technical and aesthetic specifications of the articles.





# TURRO LIVING

Design Application N° 402017000039849

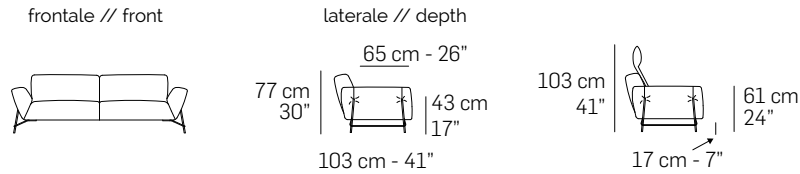

### Caratteristiche standard

- Struttura in legno e multistrato, molleggio seduta e spalliera con cinghie elastiche.
- Cuscini di seduta e bracciolo in poliuretano espanso ecologico a cellula aperta con densità differenziate.
- Cuscini di spalliera in poliuretano espanso ecologico a cellula aperta rivestito da un materassino in misto piuma.
- Rivestimento in pelle o tessuto. Tutti i rivestimenti sono fissi.
- Piede in metallo Canna di fucile (Cod.50), Bronzo anticato (Cod.52), entrambe le finiture hanno la parte inferiore verniciata in colore oro satinato.
- Cucitura Cod.03 per rivestimento in pelle e tessuto.
- Inserimento letto non possibile.
- Lato componibile rifinito.

### Caratteristiche optional su richiesta senza maggiorazione

- Disponibile con cucitura a contrasto, per la scelta del colore fare riferimento ai codici del campionario pelli.

### Caratteristiche optional su richiesta con maggiorazione

- Tavolino terminale (Cod.9503) con struttura in metallo Canna di fucile (Cod.50) e ripiano in marmo Emperador (Cod.EM) oppure marmo bianco Carrara (Cod.CA), disponibile per le versioni Cod.1591 - 1592 - 1601 - 1602 - 1691 - 1692 - 1701 - 1702 - 2901 - 2902 - 3021 - 3022.
- Poggiatesta (Cod.9900) con imbottitura in poliuretano espanso e supporto in metallo rivestito.
- Per il multi rivestimento il prezzo va incrementato del 7%. Per maggiori dettagli fare riferimento al paragrafo "NOTE" posto nelle prime pagine del listino.

### Note

- Non è possibile applicare altre cuciture.
- Per alcuni tessuti e velluti l'azienda si riserva di applicare la cucitura Cod.00 / Cod.03 (vedi immagine).

### Standard features

- Frame: wooden structure, seat and back suspensions in reinforced elastic webbing.
- Seat and arm cushions with padding in eco-friendly open cell polyurethane foam, with different densities.
- Back cushions with padding in eco-friendly open cell polyurethane foam, covered with a mixed feather layer.
- Covering in leather or fabric. Not removable coverings.
- Legs in Gunmetal (Cod.50), Antique Bronze (Cod.52), both finishes with lower part painted in matte gold color.
- Stitching type Cod.03 for leather and fabric coverings.
- No bed version available.
- Sectional sides finished.

### Optional features without any upcharge

- Stitching, unless differently requested, will be matching the leather or fabric colour.
- Contrast stitching available. Please refer to our leather collection for a thread color indication.

### Optional features with upcharge

- Terminal table (Cod.9503) with metal structure in Gunmetal (Cod.50) color and top in Emperador marble (Cod.EM) or Carrara white marble (Cod.CA) attached to the structure available for the versions Cod.1591 - 1592 - 1601 - 1602 - 1691 - 1692 - 1701 - 1702 - 2901 - 2902 - 3021 - 3022.
- Headrest (Cod.9900) with padding in eco-friendly open cell polyurethane foam and covered metal support.
- 7% upcharge for combined coverings. Please refer to the notes at the beginning of pricelist.

### Notes

- Different stitchings not available.
- For some fabrics and velvets production dept. must apply the stitching Cod.00 / Cod.03 (as per picture below).



Piede in metallo // Metal leg



Canna di Fucile (Cod.50) / Oro Satinato // Gunmetal (Cod.50) / Matte Gold color

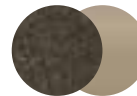

Bronzo Anticato (Cod.52) / Oro Satinato // Antique Bronze (Cod.52) / Matte Gold color

Cuciture // Stitching



Cod.00

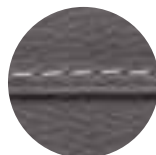

Cod.03

Poggiatesta // Headrest



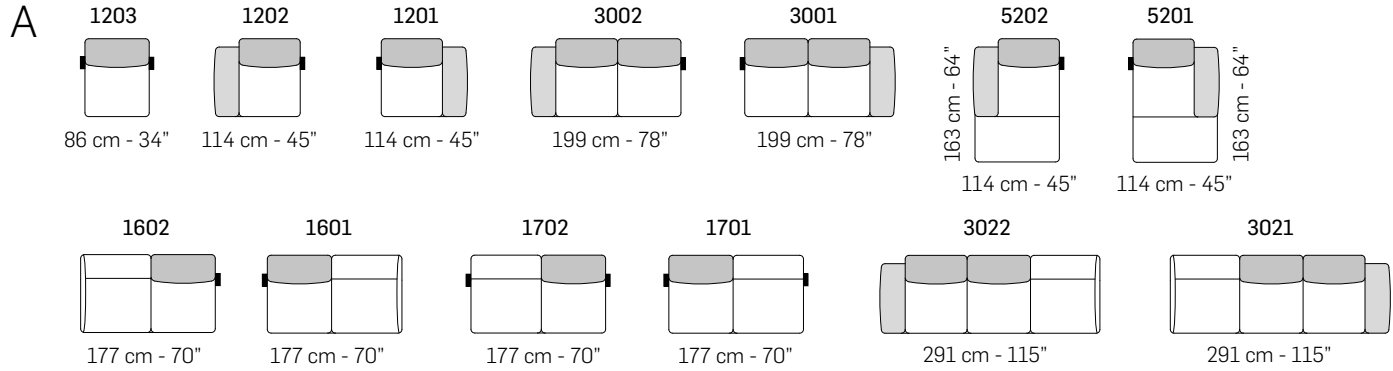
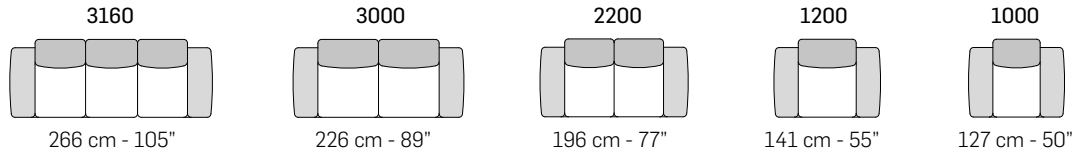

tutti gli elementi del gruppo A hanno lo stesso modulo di seduta - all items in group A have the same seat width

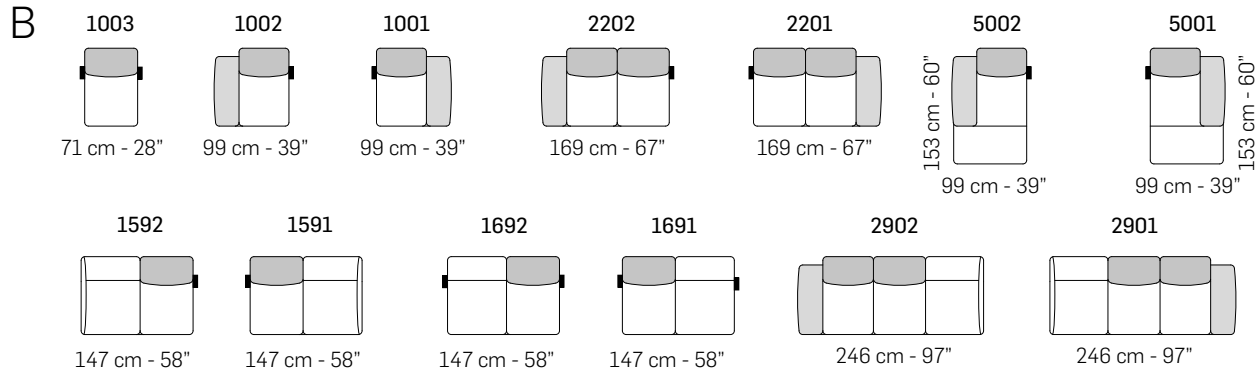

tutti gli elementi del gruppo B hanno lo stesso modulo di seduta - all items in group B have the same seat width

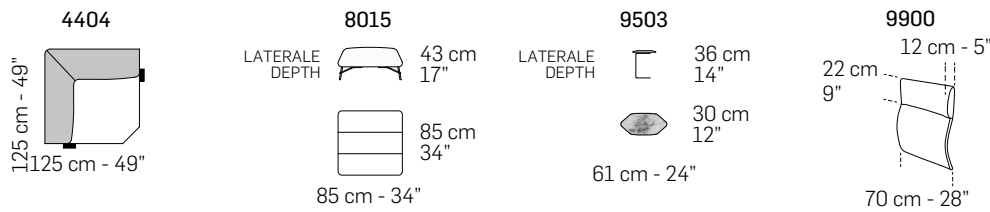

COMPOSIZIONI CONSIGLIATE / SUGGESTED COMPOSITIONS

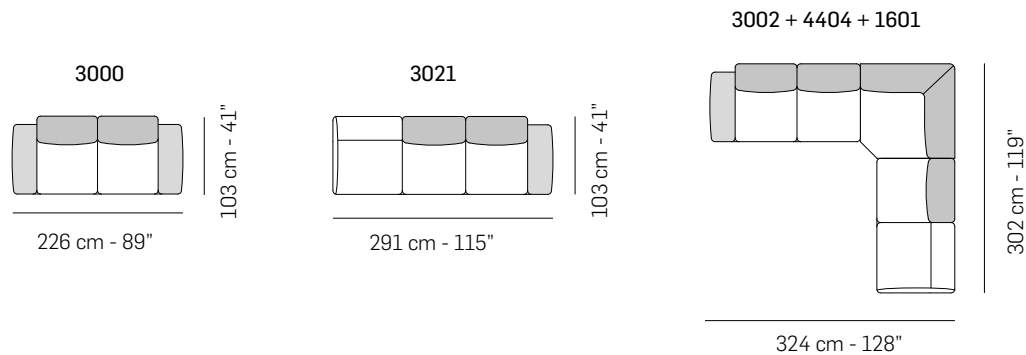

Scala 1:100  
 Ratio 1 to 100

Legenda / Legend

- Spalliera / Back Cushions
- Bracciolo / Armrest
- Marmo / Marble
- Poggiareni / Kidneyrest
- Seduta / Seat Cushions
- Aggancio Componibile / Connector

Note / Notes

Nicoline si riserva il diritto di apportare in ogni momento modifiche tecniche ed estetiche / Nicoline reserves the right to change, at any time and without prior warning, technical and aesthetic specifications of the articles.

# WAGNER

Design Application N° 402020000002749

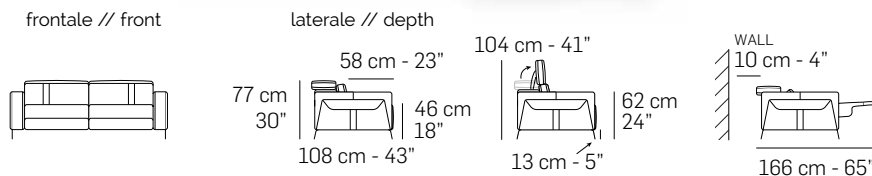

## Caratteristiche standard

- Struttura in legno e multistrato, molleggio seduta e schienale con cinghie elastiche.
- Imbottiture in poliuretano espanso ecologico a cellula aperta con densità differenziate.
- Rivestimento in pelle o tessuto. Tutti i rivestimenti sono fissi.
- Piede in metallo Canna di fucile (Cod.50), Bronzo anticato (Cod.52).
- Versioni recliner con meccanismo elettrico indipendente sia per la seduta sia per il poggiatesta.
- Versioni fisse con meccanismo poggiatesta manuale regolabile.
- Tutte le versioni contrassegnate dal simbolo ^↑, sono dotate di poggiatesta regolabile.
- Cucitura Cod.01 - 03 per rivestimento in pelle.
- Cucitura Cod.03 per rivestimento in tessuto.
- Inserimento letto non possibile.
- Lato componibile non rifinito.

## Caratteristiche optional su richiesta senza maggiorazione

- Piede in legno verniciato nei colori standard Noce (Cod.02), Wengè (Cod.05).
- Disponibile con cucitura a contrasto, per la scelta del colore fare riferimento ai codici del campionario pelli.

## Caratteristiche optional su richiesta con maggiorazione

- Batteria al litio per movimentare il meccanismo in assenza di elettricità. Considerare una batteria per ogni seduta recliner.
- Solo per le versioni dove previsto, il lato componibile può essere rifinito.
- Pannello esterno scocca bracciolo con rivestimento differente rispetto al resto del divano (Config.1).
- Pannello esterno scocca bracciolo e inserto spalliera con rivestimento differente rispetto al resto del divano (Config. 2)
- Per il multi rivestimento, tranne il pannello bracciolo e l'inserto spalliera che hanno maggiorazioni dedicate, il prezzo va incrementato del 7%. Per maggiori dettagli fare riferimento al paragrafo "NOTE" posto nelle prime pagine del listino.

## Note

- Le versioni recliner sono consegnate a moduli separati.
- Non è possibile applicare altre cuciture.
- Per alcuni tessuti e velluti l'azienda si riserva di applicare la cucitura Cod.00 / Cod.03 (vedi immagine).

## Standard features

- Frame: wooden structure, seat and back suspensions in reinforced elastic webbing.
- Paddings in eco-friendly open cell polyurethane foam, with different densities.
- Covering in leather or fabric. Not removable coverings.
- Metal legs in Gunmetal (Cod.50), Antique bronze (Cod.52).
- Electrical independent mechanism both on the footrest and headrest for reclining versions.
- Manually adjustable headrest for stationary versions.
- All the versions marked by the symbol ^↑ are equipped with adjustable headrest.
- Stitching type Cod.01 - 03 for leather covering.
- Stitching type Cod.03 for fabric covering.
- No bed version available.
- Sectional sides not finished.

## Optional features without any upcharge

- Beech wooden leg painted in standard colors Walnut (Cod.02), Wengè (Cod.05).
- Stitching, unless differently requested, will be matching the leather or fabric colour.
- Contrast stitching available. Please refer to our leather collection for a thread color indication.

## Optional features with upcharge

- Lithium battery to move the mechanism in the absence of electricity. Please consider one battery per recliner version.
- Sectional sides finished (if possible).
- External panel of the armrest frame with a different covering from the rest of the sofa (Config. 1).
- External panel of the armrest frame and backrest insertions with different covering than the rest of the sofa (Config. 2).
- 7% upcharge for combined coverings (except for the armrest panel and backrest insert which have dedicated upcharges). Please refer to the NOTES at the beginning of pricelist.

## Notes

- All reclining versions are made and delivered as separate elements.
- Different stitching not available.
- For some fabrics and velvets production dept. must apply the stitching Cod.00 / Cod.03 (as per picture below).



Piede in metallo // Metal leg



Canna di Fucile (Cod.50) // Gunmetal (Cod.50)



Bronzo Anticato (Cod.52) // Antique Bronze (Cod.52)

Piede in legno // Wooden leg



Noce (Cod.02) // Walnut (Cod.02)



Wengè (Cod.05) // Wengè (Cod.05)



Standard



(Config.1)



(Config.2)

Cuciture // Stitching

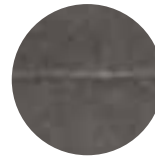

Cod.00

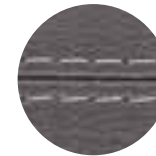

Cod.01

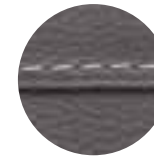

Cod.03

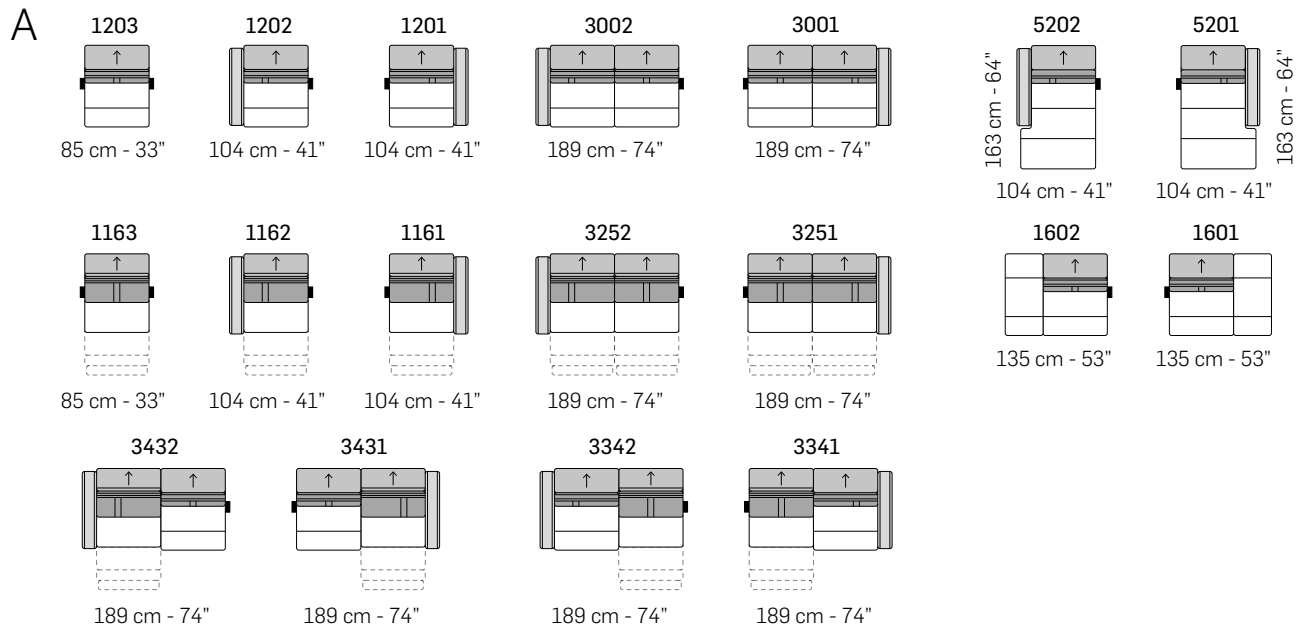
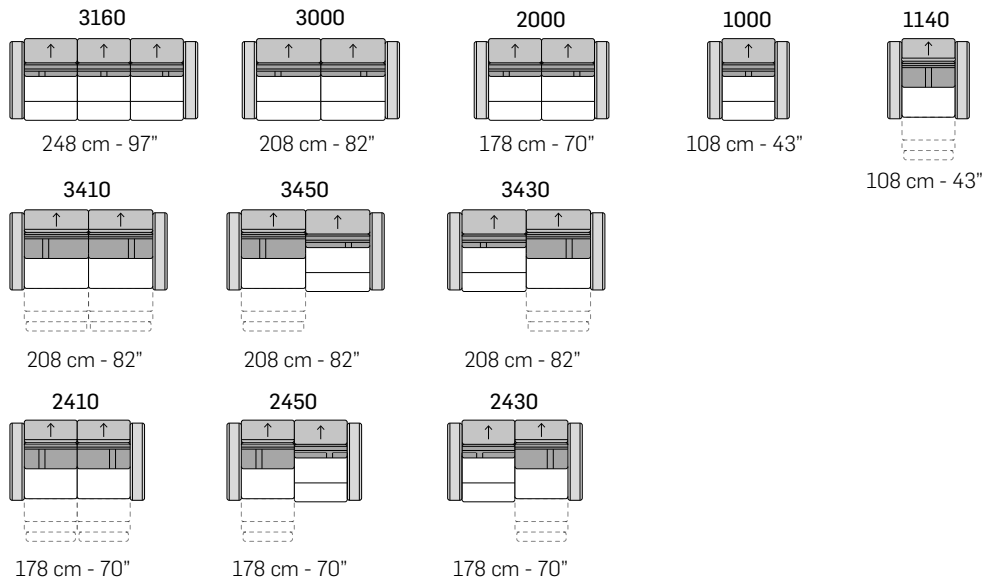

tutti gli elementi del gruppo A hanno lo stesso modulo di seduta -all items in group A have the same seat width

B

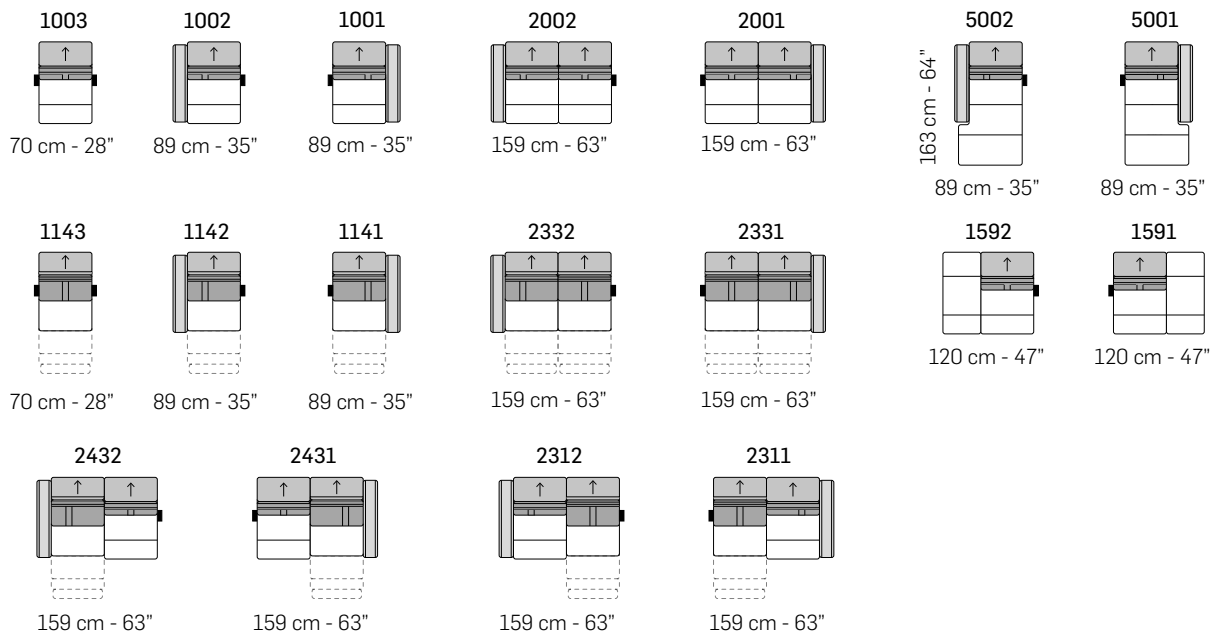

tutti gli elementi del gruppo B hanno lo stesso modulo di seduta - all items in group B have the same seat width

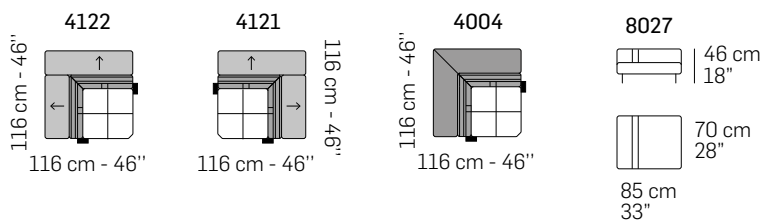

COMPOSIZIONI CONSIGLIATE / SUGGESTED COMPOSITIONS

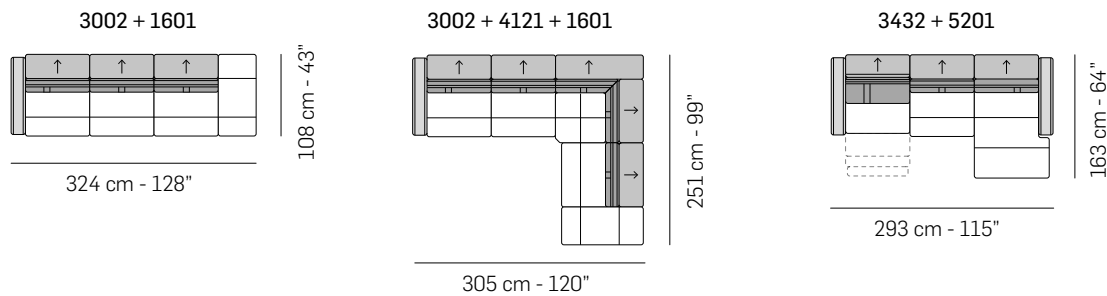

Scala 1:100  
Ratio 1 to 100

Legenda / Legend

- Spalliera / Back Cushions
- Bracciolo / Armrest
- Aggancio Componibile / Connector
- Poggiatesta regolabile / Adjustable headrest
- Poggiatesta fisso / Fixed headrest
- Seduta / Seat Cushions
- Poggiareni / Kidneyrest

Note / Notes

Nicoline si riserva il diritto di apportare in ogni momento modifiche tecniche ed estetiche / Nicoline reserves the right to change, at any time and without prior warning, technical and aesthetic specifications of the articles.





CU58  
9010

60 cm - 24"

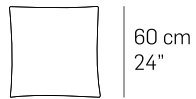

CU57  
9010

50 cm - 20"



**Caratteristiche standard**

- Imbottitura in misto piuma.
- Rivestimento in pelle o tessuto, entrambi sfoderabili.

**Note**

- Multi rivestimento non disponibile.

**Standard Features**

- Padding in mixed feather.
- Covering in leather or fabric. Removable covering.

**Notes**

- Combined coverings not available.



CU52  
9010

60 cm - 24"



CU51  
9010

50 cm - 20"

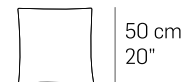

CU50  
9010

40 cm - 16"

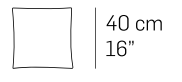

**Caratteristiche standard**

- Imbottitura in fibra di poliestere siliconata.
- Rivestimento in pelle o tessuto, entrambi sfoderabili.

**Note**

- Multi rivestimento non disponibile.

**Standard Features**

- Padding in siliconized polyester fiber.
- Covering in leather or fabric. Removable covering.

**Notes**

- Combined coverings not available.





Leather



Fabrics



CU69  
9010

70 cm - 28"



CU68  
9010

60 cm - 24"



**Caratteristiche standard**

- Imbottitura in misto piuma.
- Rivestimento in pelle o tessuto, entrambi sfoderabili.

**Note**

- Multi rivestimento non disponibile.

**Standard Features**

- Padding in mixed feather.
- Covering in leather or fabric. Removable covering.

**Notes**

- Combined coverings not available.



Leather

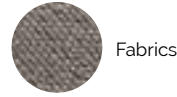

Fabrics



CU81  
9010

46 cm - 18"



**Caratteristiche standard**

- Imbottitura in fibra "Extra soft".
- Rivestimento in pelle o tessuto, entrambi sfoderabili.

**Note**

- Multi rivestimento non disponibile.

**Standard Features**

- Padding in in "Extra soft" fiber.
- Covering in leather or fabric. Removable covering.

**Notes**

- Combined coverings not available.

*Cordinated by Nicoline Marketing Department*

*Printed January 2023*

**nicoline salotti s.r.l.**

C.da Parchi Calia s.n.

Z.I. Pip 70022 Altamura (BA)

T. +39 080 3101487

[info@nicoline.it](mailto:info@nicoline.it)

[www.nicoline.it](http://www.nicoline.it)

La ditta si riserva il diritto di apportare in ogni momento modifiche tecniche ed estetiche.  
La stampa tipografica non sempre permette la fedele riproduzione dei colori e delle tinte rispetto agli originali.

*The company reserves the rights to change, at any time and without prior warning,  
the technical specifications and dimensions of the articles.*



