

# Cavour



## nicoline

Descrizione modello - *Model Description*

Dimensioni - *Dimensions*

Composizioni consigliate - *Recommended compositions*

[nicoline.it](http://nicoline.it)

ITALY - C.da Parchi Calia sn Z.I. - 70022 Altamura – BA - Telefono: +39 080 3101487

UNITED STATES - Nicoline Salotti Inc. po box 38783 - Greensboro – NC 27438 - Phone: +1 (336) 259 9881

SINGAPORE - 23 Genting Road #06-01 - Chevalier House Singapore 349481 - Telefono: +65 8168 3354

# CAVOUR

Design Application n° 402019000000467



Frontale/Front

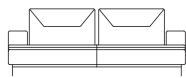

Laterale/Depth

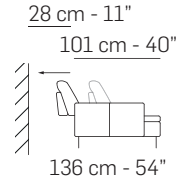
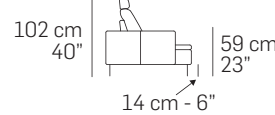
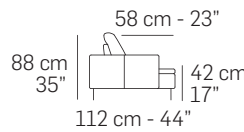

## Caratteristiche standard

- Struttura in legno e multistrato, molleggio seduta con cinghie elastiche.
- Imbottiture in poliuretano espanso ecologico a cellula aperta con densità differenziate.
- Rivestimento in pelle o tessuto. Tutti i rivestimenti sono fissi.
- Piede in metallo Canna di fucile (Cod.50), Bronzo anticato (Cod.52).
- I cuscini di schienale sono dotati di meccanismo "pendular".
- Le cuciture per il rivestimento in pelle sono realizzate nel seguente modo:
- Cucitura Cod.210 parte orizzontale della spalliera e poggiatesta;
- Cucitura Cod.01 fianco spalliera e parte superiore della seduta;
- Cucitura Cod.03 frontale seduta e bracciolo;
- Il rivestimento in tessuto possiede solamente la cucitura Cod.03.
- Inserimento letto non possibile.
- Lato componibile non rifinito.

## Caratteristiche optional su richiesta senza maggiorazione

- Disponibile con cucitura a contrasto, per la scelta del colore fare riferimento ai codici del campionario pelli.

## Caratteristiche optional su richiesta con maggiorazione

- Solo per le versioni dove previsto, il lato componibile può essere rifinito.
- Poggiatesta (Cod.9900) con imbottitura in poliuretano espanso ecologico a cellula aperta e rivestimento sfoderabile.
- Per il multi rivestimento il prezzo va incrementato del 7%. Per maggiori dettagli fare riferimento al paragrafo "NOTE" posto nelle prime pagine del listino.

## Note

- Non è possibile applicare altre cuciture.
- Per alcuni tessuti e velluti l'azienda si riserverà di applicare la cucitura Cod.00 / Cod.03 (vedi immagine).

## Standard features

- Frame: wooden structure, seat suspensions in reinforced elastic webbing.
- Paddings in eco-friendly open cell polyurethane foam, with different densities.
- Covering in leather or fabric. Not removable coverings.
- Legs in Gunmetal (Cod.50), Antique bronze (Cod.52).
- Back cushion with pendular mechanism on all elements.
- Stitchings only for the leather covering are being placed as per the following:
- Stitching Cod.210 for the horizontal part of the backrest and for headrest;
- Stitching Cod.01 for the lateral part of the backrest and the top part of the seat;
- Stitching Cod.03 for the frontal part of the seat and for the armrest;
- Stitching cod.03 only for fabric covering.
- No bed version available.
- Sectional sides not finished.

## Optional features available upon request with no upcharge

- Stitching, unless differently requested, will be matching the leather or fabric colour. Contrast stitching colour can be ordered at no extra charge. You might use as reference any Nicoline leather.

## Optional features available upon request with an upcharge

- Sectional sides finished (if possible).
- Headrest (Cod.9900) in eco-friendly open cell polyurethane foam and removable covering.
- 7% upcharge for combined coverings. Please refer to the notes at the beginning of pricelist.

## Notes

- Different stitchings not available.
- For some fabrics and velvets production dept. must apply the stitching Cod.00 / Cod.03 (as per picture below).



Piede in metallo // Metal leg



Canna di Fucile (Cod.50) // Gunmetal (Cod.50)

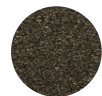

Bronzo Anticato (Cod.52) // Antique Bronze (Cod.52)



Poggiatesta // Headrest

Cuciture // Stitching

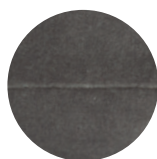

Cod.00

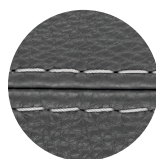

Cod.01

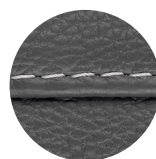

Cod.03

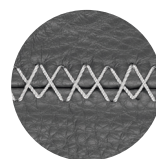

Cod.210

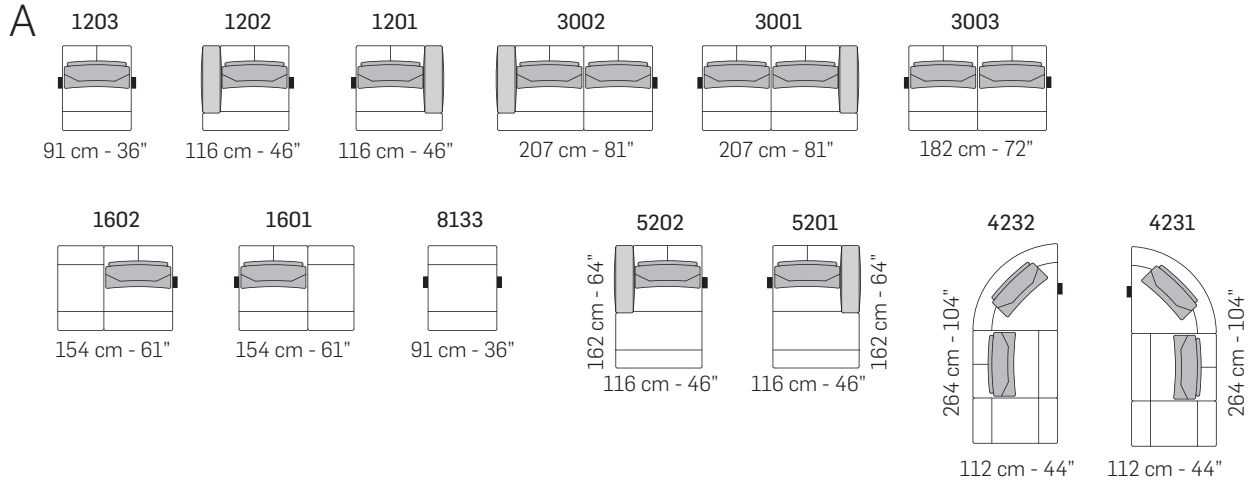
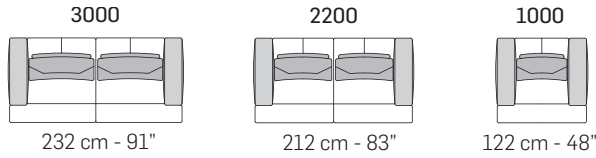

tutti gli elementi del gruppo A hanno lo stesso modulo di seduta - all items in group A have the same seat width

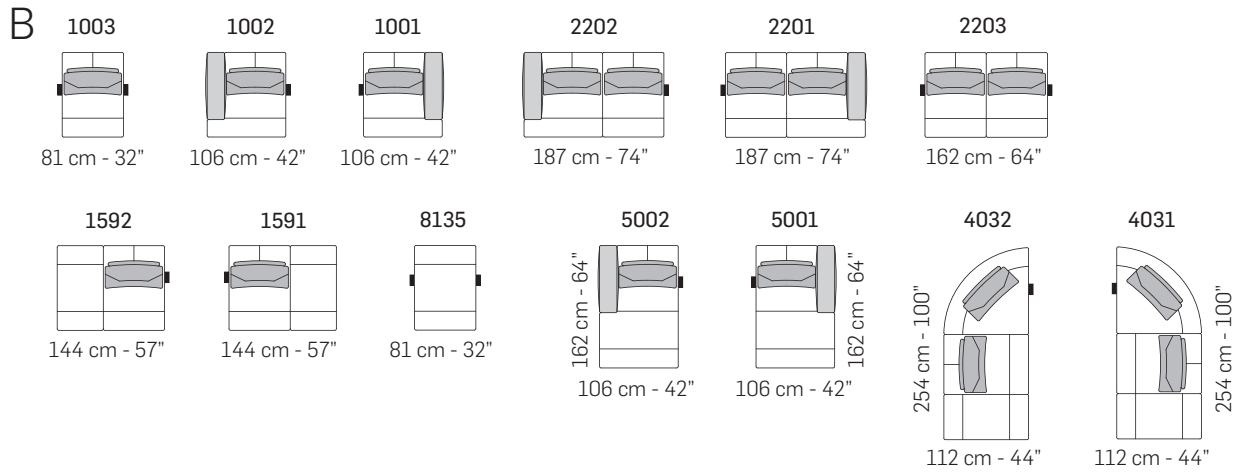

tutti gli elementi del gruppo B hanno lo stesso modulo di seduta - all items in group B have the same seat width

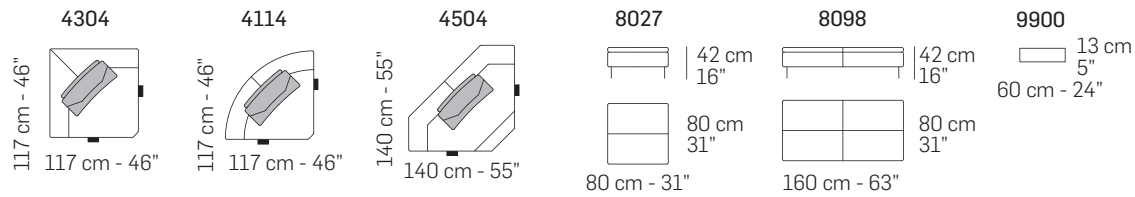

COMPOSIZIONI CONSIGLIATE / SUGGESTED COMPOSITIONS

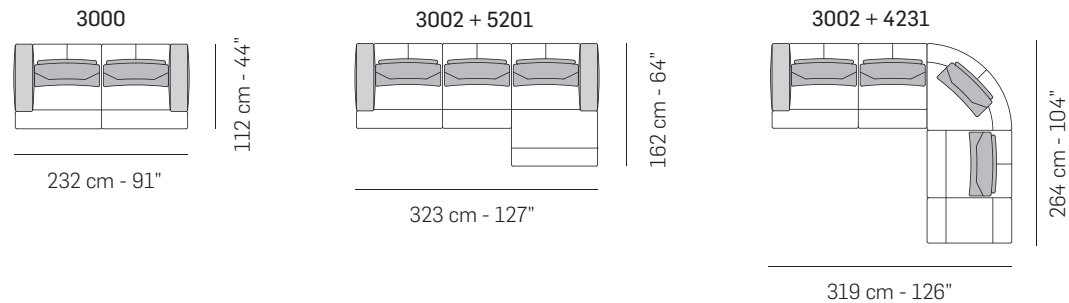

Scala 1:100  
 Ratio 1 to 100

Legenda / Legend

- Spalliera / Back Cushions
- Bracciolo / Armrest
- Aggancio Componibile / Connector
- Poggiareni / Kidneyrest
- Seduta / Seat Cushions

Note / Notes

Nicoline si riserva il diritto di apportare in ogni momento modifiche tecniche ed estetiche / Nicoline reserves the right to change, at any time and without prior warning, technical and aesthetic specifications of the articles.