

Nausicaa



nicoline

Descrizione modello - *Model Description*

Dimensioni - *Dimensions*

Composizioni consigliate - *Recommended compositions*

nicoline.it

ITALY - C.da Parchi Calia sn Z.I. - 70022 Altamura – BA - Telefono: +39 080 3101487

UNITED STATES - Nicoline Salotti Inc. po box 38783 - Greensboro – NC 27438 - Phone: +1 (336) 259 9881

SINGAPORE - 23 Genting Road #06-01 - Chevalier House Singapore 349481 - Telefono: +65 8168 3354

NAUSICAA



frontale // front

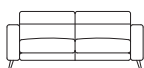

laterale // depth

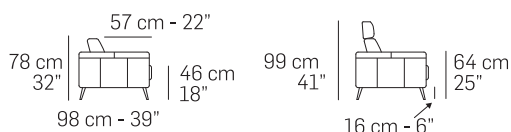

Caratteristiche standard

- Struttura in legno e multistrato, molleggio seduta e spalliera con cinghie elastiche.
- Imbottitura in poliuretano espanso ecologico a cellula aperta con densità differenziate.
- Rivestimento in pelle o tessuto con cuscini di seduta e spalliera sfoderabili.
- Solo per il mercato ITALIA il rivestimento in tessuto è completamente sfoderabile.
- Piede in metallo Lucido (Cod.30), Satinato (Cod.31), Canna di fucile (Cod.50), Bronzo anticato (Cod.52).
- Elementi Cod.1501- 1502 - 1671 - 1672 - 2341 - 2342 - 3031 - 3032 - 8091 con ripiano in marmo Emperador (Cod.EM) oppure con marmo Bianco Carrara (Cod.CA).
- Cucitura Cod.06 per rivestimento in pelle.
- Inserimento letto non possibile.
- Lato componibile rifinito.

Caratteristiche optional su richiesta senza maggiorazione

- Solo per il rivestimento in pelle, disponibile con cucitura a contrasto, per la scelta del colore fare riferimento ai codici del campionario pelli.

Caratteristiche optional su richiesta con maggiorazione

- Poggiatesta (Cod.9900) con imbottitura in poliuretano espanso ecologico a cellula aperta e rivestimento sfoderabile.
- Per il multi rivestimento il prezzo va incrementato del 3%. Per maggiori dettagli fare riferimento al paragrafo "NOTE" posto nelle prime pagine del listino.

Note

- I disegni grafici che riportano l'asterisco (*) sono sempre con lato rifinito e anche agganciabili agli elementi componibili.
- Non è possibile applicare altre cuciture.

Standard features

- Frame: wooden structure, seat and back suspensions in reinforced elastic webbing.
- Seat cushions with padding in eco-friendly open cell polyurethane foam, with different densities.
- Covering in leather or fabric. Seat and back cushions coverings removable.
- Legs in Shiny metal (Cod.30), Satin (Cod.31), Gunmetal (Cod.50), Antique bronze (Cod.52).
- Versions Cod.1501 - 1502 - 1671 - 1672 - 2341 - 2342 - 3031 - 3032 - 8091 with top in marble Emperador (Cod.EM) or White Carrara marble (Cod.CA).
- Stitching type Cod.06 for leather covering.
- No bed version available.
- Sectional sides finished.

Optional features without any upcharge

- Stitching, unless differently requested, will be matching the leather or fabric colour. Only for leather covering, contrast stitching available. Please refer to our leather collection for a thread color indication.

Optional features with upcharge

- Headrest (Cod.9900) with padding in open cell polyurethane foam and removable covering.
- 3% upcharge for combined coverings. Please refer to the notes at the beginning of pricelist.

Notes

- Versions with asterisk (*) have always the finished terminal side with the possibility to be connected to modular elements.
- Different stitchings not available.

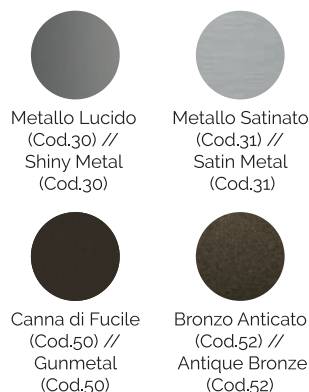

Cuciture // Stitching

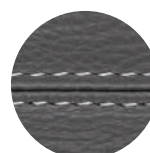

Cod.06

Piede in metallo // Metal legs

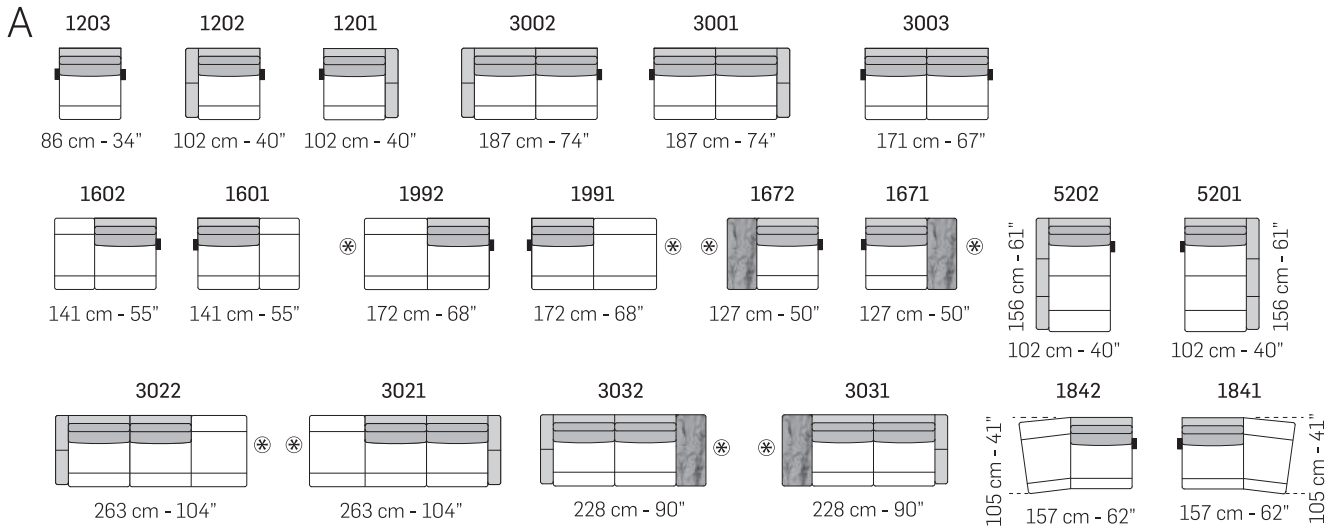
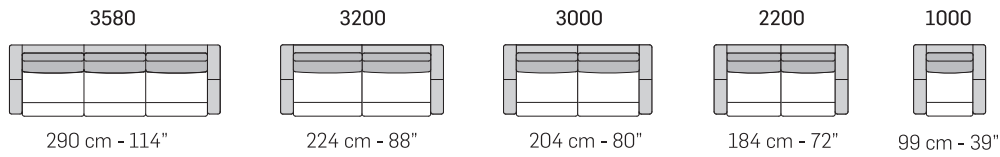

tutti gli elementi del gruppo A hanno lo stesso modulo di seduta - all items in group A have the same seat width

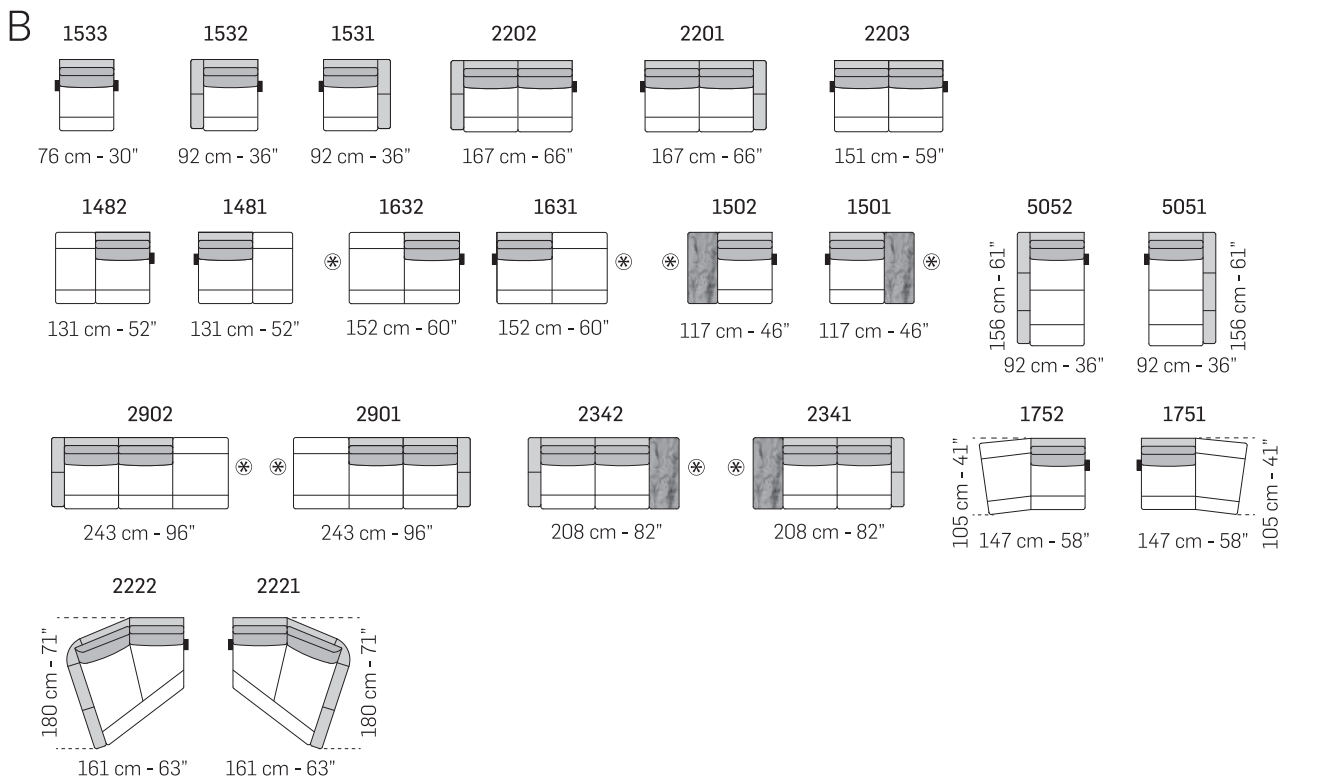

tutti gli elementi del gruppo B hanno lo stesso modulo di seduta - all items in group B have the same seat width

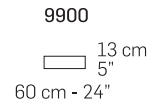
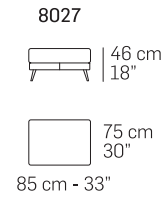
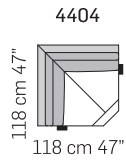
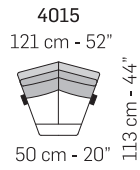

COMPOSIZIONI CONSIGLIATE / SUGGESTED COMPOSITIONS

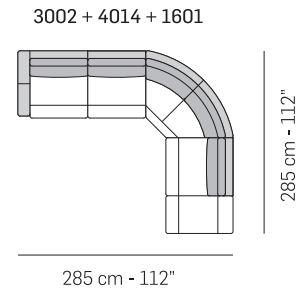
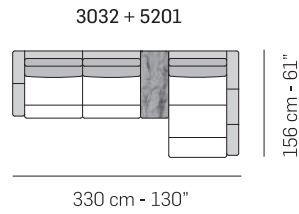
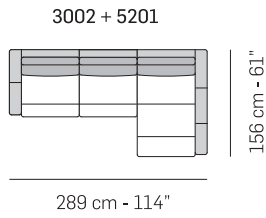

Scala 1:100
Ratio 1 to 100

Legenda / Legend

- Spalliera / Back Cushions
- Bracciolo / Armrest
- Marmo / Marble
- Poggiareni / Kidneyrest
- Seduta / Seat Cushions
- ⊗ Lato terminale sempre rifinito e agganciabile agli elementi componibili / Terminal side is always finished and it can also be connected to modular elements
- Aggancio Componibile / Connector

Note / Notes

Nicoline si riserva il diritto di apportare in ogni momento modifiche tecniche ed estetiche / Nicoline reserves the right to change, at any time and without prior warning, technical and aesthetic specifications of the articles.