

Crumble



nicoline

Descrizione modello - Model Description

Dimensioni - Dimensions

Composizioni consigliate - Recommended compositions

nicoline.it

ITALY - C.da Parchi Calia sn Z.I. - 70022 Altamura – BA - Telefono: +39 080 3101487

UNITED STATES - Nicoline Salotti Inc. po box 38783 - Greensboro – NC 27438 - Phone: +1 (336) 259 9881

SINGAPORE - 23 Genting Road #06-01 - Chevalier House Singapore 349481 - Telefono: +65 8168 3354

CRUMBLE



frontale // front

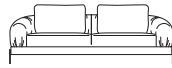

laterale // depth

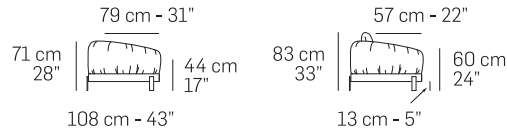

Caratteristiche standard

- Struttura in multistrato, massello di abete e molleggio seduta con cinghie elastiche.
- Imbottiture in poliuretano espanso ecologico a cellula aperta con densità differenziate.
- Cuscini di schienale in fibra "Extra soft".
- Rivestimento in pelle o tessuto con cuscini di seduta e spalliera sfoderabili.
- Elementi Cod.1421 - 1422 - 1671 - 1672 - 3031 - 3032 - 9506 - 9507 con ripiano in marmo Bianco Carrara (Cod.CA).
- Piede in metallo Canna di fucile (Cod.50), Ottone satinato (Cod.51), Bronzo anticato (Cod.52).
- Cucitura Cod.01 per il rivestimento in pelle.
- Il rivestimento in tessuto non possiede cuciture.
- Inserimento letto non possibile.
- Lato componibile rifinito.

Caratteristiche optional su richiesta senza maggiorazione

- Nessuna maggiorazione in caso di scelta dei soli cuscini schienale con rivestimento differente da quello principale.
- Solo per rivestimento in pelle, disponibile con cucitura a contrasto.
- Per la scelta del colore fare riferimento ai codici del campionario pelli.

Caratteristiche optional su richiesta con maggiorazione

- Per il multi rivestimento il prezzo va incrementato del 7%, ad eccezione di quanto riportato nel paragrafo "senza maggiorazione". Per maggiori dettagli fare riferimento al paragrafo "NOTE" posto nelle prime pagine del listino.
- Elementi Cod.1421 - 1422 - 1671 - 1672 - 3031 - 3032 - 9506 - 9507 con ripiano in marmo Emperador (Cod.EM), Nero Marquinia (Cod.NM).

Note

- I disegni grafici che riportano l'asterisco (*) sono sempre con lato rifinito e anche agganciabili agli elementi componibili.
- Non è possibile applicare altre cuciture.

Standard features

- Frame: wooden structure, solid fir wood and seat suspensions in reinforced elastic webbing.
- Paddings in eco-friendly open cell polyurethane foam, with different densities.
- Back cushions in "Extra soft" fiber.
- Covering in leather or fabric. Seat and back cushions coverings removable.
- Versions Cod.1421 - 1422 - 1671 - 1672 - 3031 - 3032 - 9506 - 9507 with top in White Carrara marble (Cod.CA).
- Legs in Gunmetal (Cod.50), Satin Brass (Cod.51), Antique bronze (Cod.52).
- Stitching type Cod.01 for leather covering.
- No stitchings for fabric covering.
- No bed version available.
- Sectional sides finished.

Optional features without any upcharge

- No upcharge in case of back cushions only with different covering from the primary one.
- Stitching, unless differently requested, will be matching the leather or fabric colour. Only for leather covering, contrast stitching available. Please refer to our leather collection for a thread color indication.

Optional features with upcharge

- 7% upcharge for combined coverings, except as indicated in the paragraph "without any upcharge". Please refer to the notes at the beginning of pricelist.
- Versions Cod.1421 - 1422 - 1671 - 1672 - 3031 - 3032 - 9506 - 9507 with top in marble Emperador (Cod.EM), Black Marquinia marble (Cod.NM).

Notes

- Versions with asterisk (*) have always the finished terminal side with the possibility to be connected to modular elements.
- Different stitchings not available.



Canna di Fucile (Cod.50) //
Gunmetal (Cod.50)



Ottone Satinato (Cod.51) //
Satin Brass (Cod.51)



Bronzo Anticato (Cod.52) //
Antique Bronze (Cod.52)

Cuciture //
Stitching

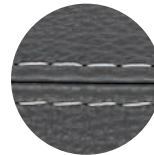

Cod.01

Piede in metallo //
Metal legs

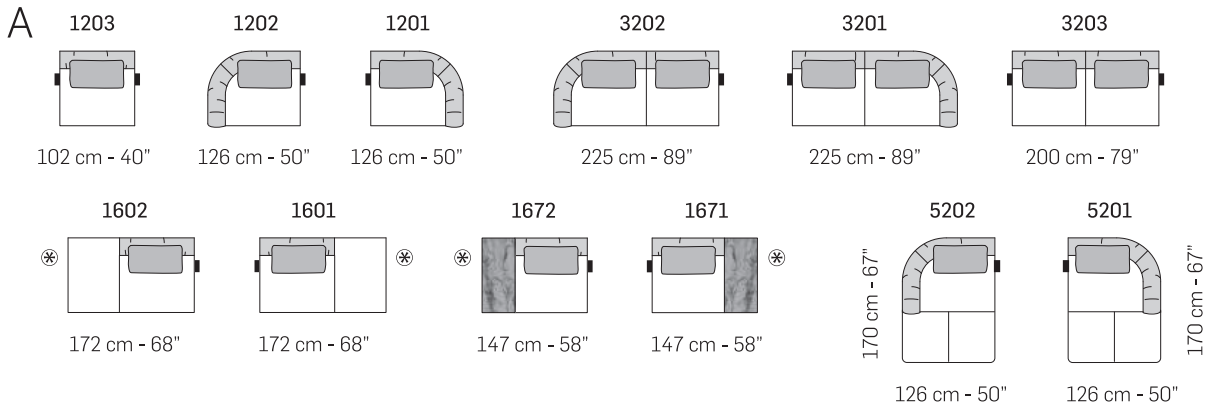
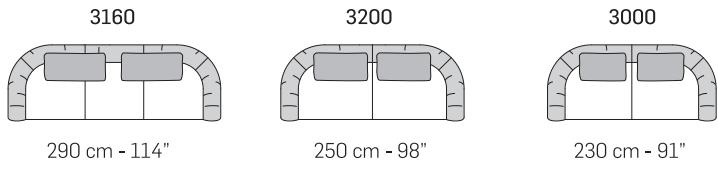

tutti gli elementi del gruppo A hanno lo stesso modulo di seduta - all items in group A have the same seat width

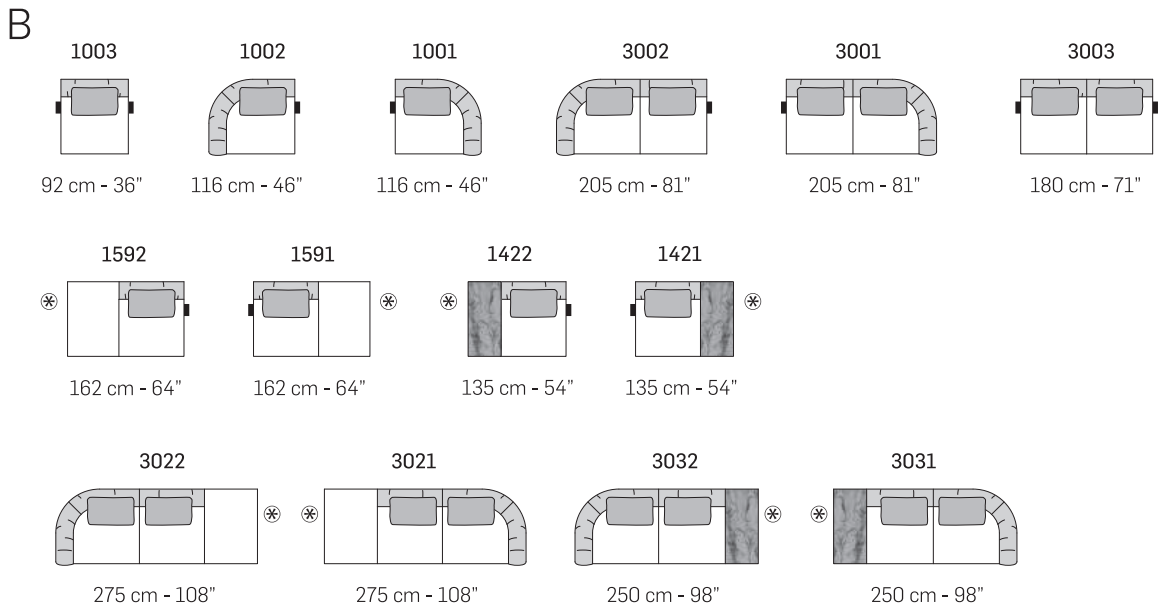

tutti gli elementi del gruppo B hanno lo stesso modulo di seduta - all items in group B have the same seat width

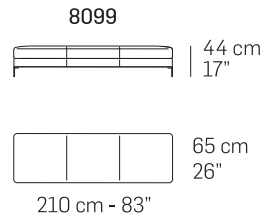
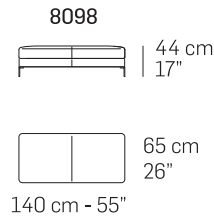
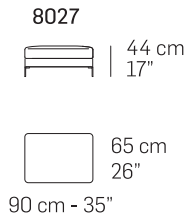
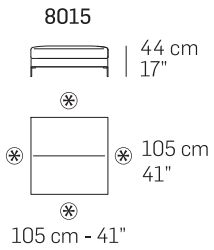
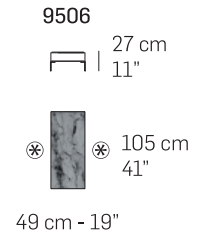
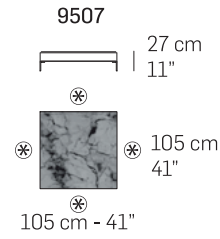
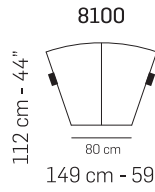
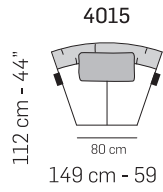
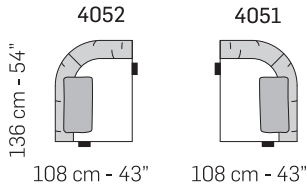
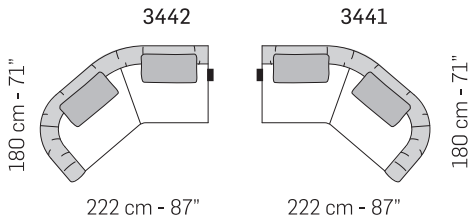

CUSCINETTI CONSIGLIATI / SUGGESTED PILLOWS

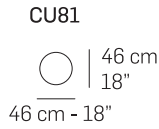
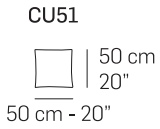

COMPOSIZIONI CONSIGLIATE / SUGGESTED COMPOSITIONS

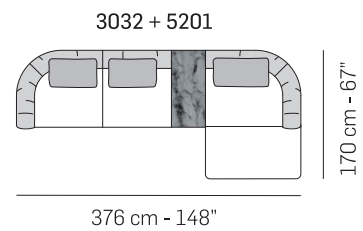
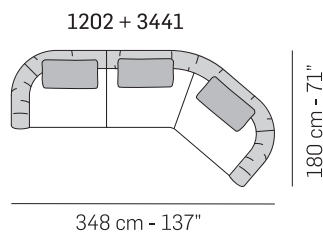
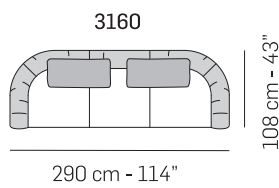

Scala 1:100
Ratio 1 to 100

Legenda / Legend

- Spalliera / Back Cushions
- Bracciolo / Armrest
- Poggiareni / Kidneyrest
- Seduta / Seat Cushions

Marmo / Marble

⊗ Lato terminale sempre rifinito e agganciabile agli elementi componibili / Terminal side is always finished and it can also be connected to modular elements

■ Aggancio Componibile / Connector

Note / Notes

Nicoline si riserva il diritto di apportare in ogni momento modifiche tecniche ed estetiche / Nicoline reserves the right to change, at any time and without prior warning, technical and aesthetic specifications of the articles.